

Altech Corp.®

Serving the Automation & Control Industry Since 1984

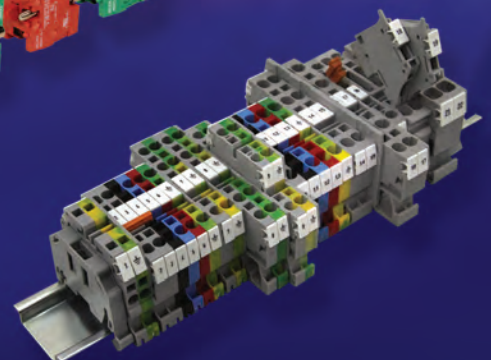

ISO 9001
QMI-SAI Global

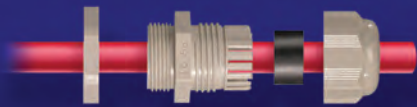
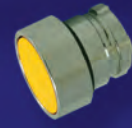
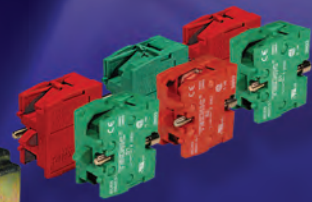

PRODUCT PREVIEW
altechcorp.com

Table of Contents & Typical Application Chart

			PAGES
CIRCUIT PROTECTION DEVICES (Circuit Breakers, Contactors, Disconnects, Fuses, Fuse Holders, Distribution)			4-6
	<ul style="list-style-type: none"> Automotive HVAC Metal working i.e. CNC machines Pollution control Test equipment Trains Water desalination 	<ul style="list-style-type: none"> Extrusion equipment manufactures Hydraulic control Packaging machinery Semiconductor Theater lighting UL 508 A panel shops Wind generation 	<ul style="list-style-type: none"> Food equipment manufactures Irrigation, waste Paint heating machinery Solar combiner boxes Traffic control systems Water & sewage Yachts
DC POWER SOLUTIONS			15
	<ul style="list-style-type: none"> Assembly production Building technology Electronic automation Machinery construction Photovoltaik Safety engineering Steel production Textile machinery Wind turbines 	<ul style="list-style-type: none"> Automation Data centers Feeding systems Molding machines Power supply Ship building Switchgear production Tunneling machines 	<ul style="list-style-type: none"> Automotive industry Disability assistance Industrial PC Packaging Rail vehicles Stations control technology Telecommunications and control Water supply
DIN ENCLOSURES			12
	<ul style="list-style-type: none"> Alarm modules Home automation Meters Safety controllers Sensor controls (liquid level) Temperature controller Transducer 	<ul style="list-style-type: none"> Analyzers Insulation monitor Power monitor Safety modules Signal converter Test devices Transmitters 	<ul style="list-style-type: none"> Encoders Interface relays Power sensor Sensing and monitoring devices Surge suppressor Timers
DIN RAIL TERMINAL BLOCKS (Terminal Blocks, Eurostrips®, Ceramic Blocks, DIN Rail, Ferrules)			7-9
	<ul style="list-style-type: none"> Appliances Food equipment manufacturers Hot melt glue guns HVAC manufacturers And HVAC panels Street light camera systems and cabinets 	<ul style="list-style-type: none"> Environmental chambers Furnaces Medical equipment, pump Military Transportation i.e. Railway, bus lines 	<ul style="list-style-type: none"> Floor light boxes Heaters Price sensitive wiring applications UL 508 panel shops
DISCONNECT SWITCHES			5
	<ul style="list-style-type: none"> Conveyor control i.e. Warehousing Food processing Portable power stations UL 508 panel shops Theater lighting UL 508 panels Wind generation 	<ul style="list-style-type: none"> Door lifts Metal stamping machines Robots Solar combiner boxes Traffic control systems Water & sewage Yachts 	<ul style="list-style-type: none"> Fire control systems Municipal pump stations Surge protection equipment Test equipment Trains Water desalination
DISTRIBUTION POWER BLOCKS			6
	<ul style="list-style-type: none"> Commercial Military Switchgear 	<ul style="list-style-type: none"> Control panels Power distribution system Wind generation 	<ul style="list-style-type: none"> General industrial Solar industry
INDUSTRIAL ENCLOSURES			10-11
	<ul style="list-style-type: none"> Agricultural – feed/water devices Conveyor systems Gas detector Lighting junction box Monitoring and sensing devices Solar UL panel shops 	<ul style="list-style-type: none"> Alarm systems Cranes HMI Machine builders Power distribution boxes Switch box Vehicle tracking/monitoring 	<ul style="list-style-type: none"> Control boxes Disconnect box HVAC Mining Refrigeration Terminal boxes Water treatment
LIQUID TIGHT STRAIN RELIEFS			12
	<ul style="list-style-type: none"> Any enclosure application (terminal box, distribution box, etc.) Control enclosures Sensor applications Water treatment 	<ul style="list-style-type: none"> Machine builders Solar 	<ul style="list-style-type: none"> Automotive Petroleum industry UL panel shops

PCB TERMINAL BLOCKS



Circuit board manufacturers
Irrigation control systems

Contract manufacturer's
Medical devices

Electronic test equipment
Panel shops

PAGES

8

POWER SUPPLIES



Aircraft applications
Automation engineering
Control panel application
Elevator / escalator applications
IT
Low voltage applications
Oil refineries
Vending machine

ATM
Automation process
Data centers
Home automation controller
Led lighting
Machine safety applications
Smart building applications
Wind turbines

Automatic door
Automotive applications
Electrical appliances
Hospitals
Led signage/ display
Oil and gas stations
Solar panels applications

15

PUSH BUTTONS AND E-STOP



Control panels
Conveyor systems
Motor controllers
Medical treatment and diagnostic
Metalworking
Food processing
Packaging equipment
Lifting/moving equipment
Electronic production equipment
Compressor control
Construction/building material handling

Industrial automation
Sorting machines
Contactor control
Lifting/moving and transportation Equipment
Wood production
Printing
Semiconductor fabrication equipment
Plastics & rubber processing
Paper & cardboard production equipment
Laundry/dry cleaning facilities

Equipment control
Automated door controls
Human machine interface (HMI) controls
Overhead and gantry crane controls
Textile production
Medical laser & x-ray equipment
Pumping station control
Materials handling
Inspection/testing equipment
Transportation equipment control

13

RELAYS (Safety, Solid State, Relay Modules, Smart Relays, Industrial, Slimline)



Bailers
Emergency stop modules
Lift equipment
OEM's
System integrators

Conveyor systems
Instrumentation / PLC houses
Light curtains
Railway
UL 508 panel shops

Elevator/escalators
Laser systems
Machine safety
Sorters

16

SAFETY & LIMIT SWITCHES



Agricultural equipment
Elevators & escalators
Machine tool
Printing

Automotive
Food processing
Metal forming
Robotics

Conveyor systems
Injection molding
Packaging
Woodworking

14

SENSORS (Inductive, Metal Detection)



Agriculture
Food industry
Plastic industry

Automotive
Military applications
Recycling

Fish nursery
Rail car manufacturer

17

TIMERS



Car washes
Process control equipment

Consumer electronics
Toll gates

Industrial equipment
UL 508 panel shops

16

TOWER LIGHTS



Automated assembly lines
Control cabinets
Machine status indication
Visualize reduction in time-loss from down-time

Automated conveyor system
Equipment monitoring from a remote station
Processing machine
Warehouse automation

Call for parts, service, or pickup
Grocery stores
Remote monitoring
Warning indication

18

CUSTOM ASSEMBLIES19
DIGITAL PANEL METERS.....18
MARKING SYSTEMS.....19
MECHANICAL THERMOSTATS18

PIN & SLEEVE DEVICES.....18
PROCESS CONTROLLERS.....18
SUSPENSION SYSTEMS.....12
WIRE DUCT.....18

Serving the Automation and Control Industries Since 1984

CIRCUIT PROTECTION



**Current Limiting
UL 489 Breakers**



Circuit Protection Devices

- UL 489, UL 508 and UL 1077 available
- Two lines of AC or DC UL 489 Miniature Molded Case Circuit Breakers
- UL 508 Manual Motor Controllers "Suitable as Motor Disconnect"
- Three Phase Adjustable Trip Miniature Circuit Breakers/ Manual Motor Controllers
- Two lines of UL 1077 Recognized Supplementary Protectors
- UL 489 Listed Molded Case Circuit Breakers, up to 1200A
- Flange and Rotary Handles available



2 Pole versions available



Busbars

- UL 1077/ UL 508 Busbars is rated up to 200A
- Can be used with most competitor's supplementary protectors and manual motor controllers
- UL 489 Busbars with ratings of up to 115A
- Modular UL 489 Busbar available
- UL listed for use with most of Altech's competitor's UL 489 Miniature Circuit Breakers
- Power Distribution System is a new way to simplify existing wiring methods inside a panel.
- Input connector Blocks up to 800A



An industry leader in UL Circuit Protection.

Ground Fault Equipment Protectors



UL 489
Branch Circuit Breaker with Ground Fault Relay

UL 489
1st in the industry

- 1P + N, 2P and 2P + N versions
- 240V AC and 120/240V AC
- 10, 30, 100, and 300 mA Residual Current Sensitivity
- Rated Current 5 - 40A
- Rated Short Circuit Interrupt Capacity 10kA
- Rated Frequency 50/60Hz
- Overload tripping B, C and D



UL 1053
Ground Fault Sensing and Relaying Device

- 1P + N and 3P + N versions
- 277V AC and 480Y/277V AC
- 10, 30, 100, 300 and 500 mA Residual Current Sensitivity
- Rated Current 25, 40 and 63A
- Rated Short Circuit Withstand Capacity 10kA
- Rated Frequency 50/60Hz



UL 1053
Ground Fault Relay with Overload Protection

- 1P + N and 3P + N versions
- 277V AC and 480Y/277V AC
- 10, 30, 100, 300 and 500 mA Residual Current Sensitivity
- Rated Current 5 - 40A
- Rated Short Circuit Withstand Capacity 10kA
- Rated Frequency 50/60Hz
- Overload tripping B, C and D

CIRCUIT PROTECTION

Extremely broad line of Motor Disconnects

- UL 508 Listed Manual Motor Controllers for AC Motor Across-the-line, AC General Use.
- Electrical ratings up to 150A/600V
- 30A / 600V AC Fused Disconnect
- Suitable for Motor Disconnect Means
- 80A disconnect is smallest in industry
- Horsepower rated to 75hp
- Extended and direct handles, toggle switches DIN Rail and panel mount
- Enclosed plastic, aluminum, sheet metal, and stainless motor disconnect switches



Enclosed Motor Disconnect Switches



Polycarbonate

These enclosed switches can be used locally at the motor. They are IP65 rated and UL Type 4X, resistant against many chemicals and UV.



Sheet Metal

These UL Type 4X tested enclosures offer good corrosion and UV resistance. They are also resistant against many chemicals. The handle is lockable and defeatable. The enclosure is also rated to IP65.



Stainless Steel

These UL Type 4X tested enclosures are ideal where chemicals are used for cleaning and maintenance such as food processing plants and breweries. Mining is another application area. Their stainless steel (Grade AISI 316) construction is extremely resistant to corrosion, and the enclosure is also rated to IP66.



Aluminum

UL Type 4X tested
Excellent in harsh weather conditions
UV resistant
Resistant to many chemicals
IP66 Protection Level
Lockable and Defeatable Handle



Stainless Steel



UL Type 4X Stainless Steel (AISI 316) Safety Switch enclosures are ideal for hygienic and harsh environments such as the food and pharmaceutical industries. They are easy to install and clean, acid proof and pad lockable. They range from 16 - 125 Amps. One version has an angled rain hood design.

Contactors



MOTOR CONTACTORS, OVERLOAD RELAYS & MANUAL MOTOR STARTERS

- Single Phase (115 -230V)
- Three Phase (200 - 575V) AC and DC Coils
- 3 and 4 pole configurations at 10A to 1200A.
- A large variety of coil voltages are supported
- Accessories include auxiliary contacts and overload relays
- Mini contactors come in screw clamp, fast-on, and solder pin types

CIRCUIT PROTECTION & DISTRIBUTION

Distribution Solutions

1 & 3 PHASE

POWER DISTRIBUTION BLOCKS

- For use with copper and aluminum cable (solid and stranded)
- Quick mounting and wiring
- IP20 Finger Safe
- 600V AC/DC
- Current Ratings available, 90A to 255A
- Outputs available, 6 - 18
- DIN Rail or Panel Mount
- Blocks fit with other DIN Rail mountable modular devices
- Accessories increase the number of outputs with only one input (for specific models)
- No caps to open or remove
- Housing: Polyamide
- Metal Body: Aluminum (tin plated) or Brass



Hybrid Power Distribution Block

- Compact 16 mm width
- Saves Panel Space, Installation Time and Cost
- 1 Screw Clamp Input: 600V / 115A; 14-2 AWG wire size
- 4 Spring Clamp Outputs: 600V / 41A; 24-8 AWG wire size
- Amount of outputs are EXPANDABLE

Fuses and Fuse Holders for Industrial & Photovoltaic Applications



- Extensive line of in-stock European Fuses minimizes downtime
- Diazed, Neozed, Cylinder, NH Knife Blade and Semiconductor fuses
- Slow Blow, Fast Blow and Superfast Blow operating classes



1000V DC

- Fuse Holders
- Crossable with many brands
- IEC and VDE electrical ratings
- Complete line of accessories

up to
1500V DC
/500A

CC & J Type



- Rejection member to allow only Class CC fuses
- Rated voltage: 600V AC/DC
- Rated current: 30A
- 1, 1N, 2, 3, 3N pole versions
- 200 kA SCR rating

Midget Type



- Rated voltage: 600V AC/DC
- Rated current: 30A
- 1, 1N, 2, 3, 3N pole versions
- 200 kA SCR rating
- Optional blown fuse indication

IEC Type



- Rated voltage: 600V AC/DC
- Rated current: up to 100A
- 1, 1N, 2, 3, 3N pole versions
- 200 kA SCR rating
- Optional blown fuse indication

DIN RAIL TERMINAL BLOCKS

Extremely Large Variety

Screw Clamp Terminal Blocks

- Most Competitive in the Industry
- International Approvals
UL, CSA, IEC, Lloyd, ATEX, IECEX, VDE, AEx
- Wide Range of Terminals and accessories
- Wire size up to 250kcmil
- Up to 240A
- Solutions for many special applications
- Power Distribution
- Disconnect & Test Terminals
- Temperature Measurement
- Space Saving Solutions
- Fuse Terminals
- High Current
- High Voltage
- Solar
- Electronic Components
(Diodes, Resistors, etc)
- Sensors
- Grounding



Feed-Through
CTS4U-N

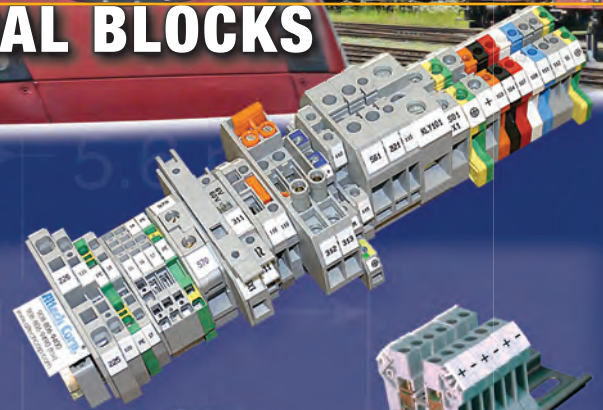

Distribution
CMDB4

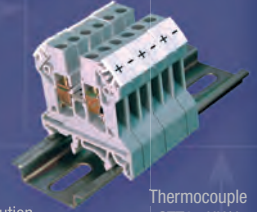

Thermocouple
CTT2.5UK/J



Various colors
are available



Electronic Component
CD4U(E)MOV



High Voltage
CHV6U



Disconnect
CKT4U



Ground Block
CGT4U

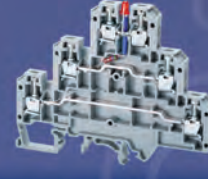

Triple Level
CTL2.5



Fuse Block
CF4U

CX Series Spring Clamp Terminal Blocks

- Very Compact profile to save panel space (CX4 most compact in industry)
- Center marking Area
- Push-In Jumper System for fast installation
- Maintenance free spring clamp design
- Suitable for Vibration applications
- Wide range of terminal block types and accessories



Multi-Connection
CXG2.5



Double Level
CXDL2.5



5x20 Fuse Block
CXF4



Feed-Through
CX4



Disconnect
CXK2.5



Push-in
Jumpers

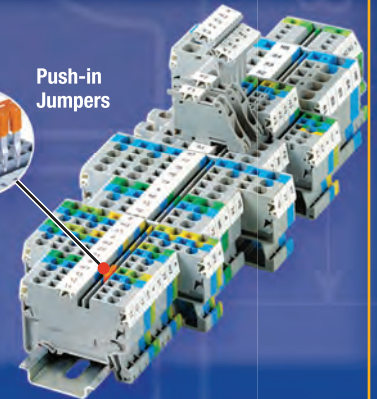

CMB4



CMT4



CSTSN4U



PTB35/50

Panel Mount / Mini Terminal Blocks

- Screw clamp series (CMB4)
- Spring clamp series (CSCP2.5)
- 15mm Rail version available (CMT4)
- Extremely compact
- Series feature high density to save panel space
- Cost effective
- Various color and accessories



CSCP2.5

Ring Tongue / Stud Terminal Blocks

- Bolt version
- Captive nut version
- Power Blocks up to 230A
- Secure and safe connection for severe vibration applications



STH4

PCB TERMINAL BLOCKS

Diverse Selection and Styles

Screw Clamp PCB Terminal Blocks



Fixed PCB Terminals

- Metric (mm) and US (inch) pin spacing (3.50mm to 12.7mm)
- Single, Double and Triple Level versions
- Various clamp styles
- Vertical, horizontal types
- Modular configuration for faster availability
- 2 and 3 to create multi-pole PCB assemblies
- Angled versions (35° and 45° wire entry)
- Various colors available
- Custom imprints

PCB Plugs & Headers

- Metric (mm) and US (inch) pin spacing (3.50mm to 10.00mm)
- Horizontal/ vertical Plugs and headers
- Screw flange versions
- Double Level Headers
- Phoenix Contact compatible
- Custom Imprints

Spring Clamp PCB Terminal Blocks



Push-In Technology

- 2.50mm, 3.50mm with 45° wire entry
- 2.54mm, 3.81mm vertical and horizontal versions
- 5.00mm spacing with push-lever operation
- 5.08mm single mold terminal
- Maintenance free push-in technology
- Modular
- Various colors

Power Terminals Push-In

- 5.00mm, 7.50mm, 11.50mm pin spacing
- Horizontal and vertical versions
- Up to 600V voltage rating
- Up to 35A current rating
- Modular
- Various colors

Tension Spring Technology

- 5.00mm, 7.50mm, 10.00mm pin spacing
- Various styles of push-lever actuators
- 45° wire entry
- 5.00mm/ 5.08mm multi level terminal
- Maintenance free tension spring technology
- Modular • Various colors

Pluggable Push-In Terminals

- 3.50mm/ 3.81mm version
- 5.00mm/ 5.08mm version
- Horizontal vertical plug
- Screw flange version
- Fits industry standard horizontal and vertical headers

TERMINAL BLOCKS & ACCESSORIES

Unique Terminal Blocks, Mounting & Connectors

Terminal Strips Eurostrip® Style



- Easy Mounting and Connection
- Reliable Connection Every Time
- Up to 63A
- Feed-through Flat Base (300V)
- Feed Through Standoff Feet (600V)
- Pluggable Version
- Various Accessories

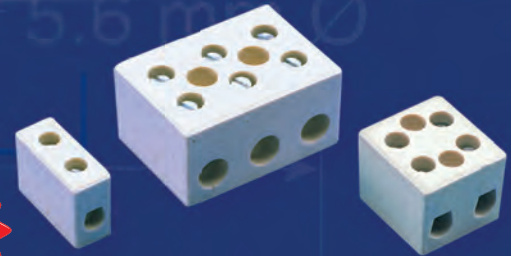
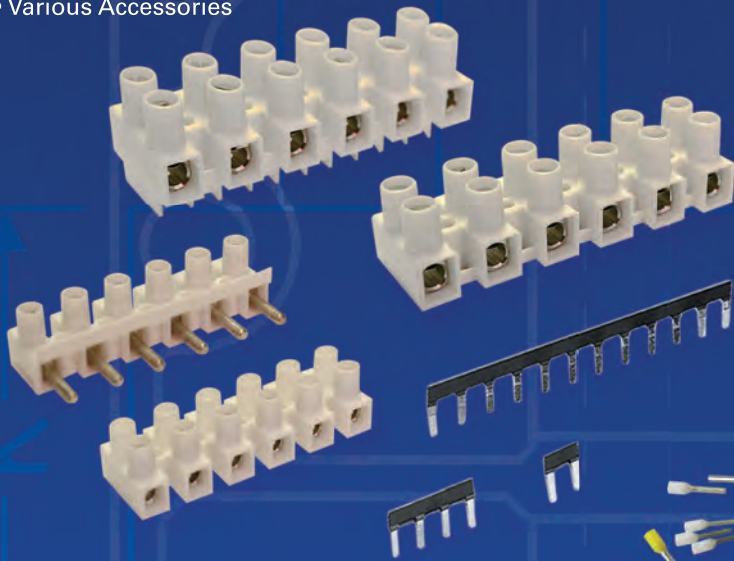

Ceramic Blocks Euroblock™ Style



- Compact, space saving
- Tubular screw clamp
- Free float or panel mount
- Temperature range: -40°C (-40°F) to 600°C (1112°F)
- Standard color: white
- Material:
 - Housing: Steatite
 - Clamp: Brass
 - Screws: Zinc plated steel

DIN Rail & Accessories

- 35mm, 32mm, 15mm
- Perforated or un-perforated
- Standard rail is steel with galvanic zinc plating and passivation
- Aluminum Rail is made of Aluminum
- Stainless steel rail is made of AISI 304 type stainless steel



DIN Rail Mounting Clip



UL Recognized Ferrules

- UL Single Insulated Wire Ferrules
- UL Twin Insulated Wire Ferrules
- UL Insulated Wire Ferrules on Reel or Belt
- Insulated Industry Standard Wire Ferrules
- Insulated DIN Standard Wire Ferrules
- Uninsulated Industry Standard Wire Ferrules
- Insulated Dual Wire Ferrules
- Insulated Ferrules Assortment Box
- Crimpers

INDUSTRIAL ENCLOSURES



TK SERIES

- 18 different enclosures with up to 3 different cover heights
- IP66 (NEMA Type 4X)
- Polystyrene or Polycarbonate
- Gray or tinted transparent covers
- Smooth sidewalls or sidewalls with knockouts
- Knockout mounting holes in enclosure base
- Tongue and groove with polyurethane gasket (CFC free)
- Non flammable and halogen free



HF - EMC models available

50 x 52 x 35 to 360 x 254 x 165 mm
1.97 x 2.05 x 1.38 to 14.2 x 10.0 x 6.50 in



Custom Assemblies & Printing



TG SERIES

- 16 sizes available
- IP67 (NEMA TYPE 4X)
- ABS or Polycarbonate
- Gray or transparent covers
- Smooth sidewalls
- Integral cover retainers
- Recessed cover for labels or membrane keypads
- Flame resistant and halogen free

84 x 82 x 55 to 302 x 232 x 110 mm
3.31 x 3.23 x 2.17 to 11.89 x 9.13 x 4.33 in



AK SERIES

- Direct mount
- Corrosion and maintenance free
- Polycarbonate base and cover
- Polycarbonate transparent doors
- Integral seals
- High mechanical strength
- Halogen free
- Up to IP65 protection



Dust and moisture proof

100 x 150 x 96 to 900 x 300 x 142 mm
3.94 x 5.91 x 3.78 to 35.43 x 11.81 x 5.59 in

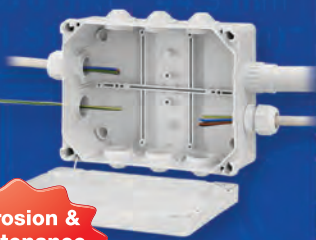

Corrosion & maintenance free



HP SERIES

- Direct mount
- Semi rigid polypropylene
- Dust and splash proof
- Contact labyrinth seal
- Temperature range up to 100°C (212°F)
- IP54 protection • Non-flammable • Low halogen
- Universal entry seals • Standard rear knockouts
- Drainage inlets

75 x 75 x 42 to 199 x 149 x 70 mm
2.95 x 2.95 x 1.65 to 7.83 x 5.87 x 3.03 in

Impervious to sea, air & water



ABOX-i SERIES

- Direct mount
- Glass reinforced Polycarbonate
- IP65 protection • Integral seal
- High temperature resistance 120°C (248°F)
- Corrosion and maintenance free
- Halogen free • High chemical resistance
- UV fade resistance for optimal outdoor use
- Ideal for installations in high risk fire areas



80 x 80 x 52 to 250 x 250 x 115 mm
3.15 x 3.15 x 2.05 to 9.84 x 9.84 x 4.53 in

INDUSTRIAL ENCLOSURES



AL SERIES

- Cast aluminum
- 24 enclosure sizes
- Exterior of the enclosure is protected by powder coating (silver-gray - RAL 7001)
- IP65 protection
- High degree of resistance to chemicals and other damaging materials
- Protection against electromagnetic interference (EMI)

50 x 45 x 30 to 388 x 270 x 117 mm
1.97 x 1.77 x 1.18 to 15.28 x 10.63 x 4.61 in

Protect from weather & corrosion

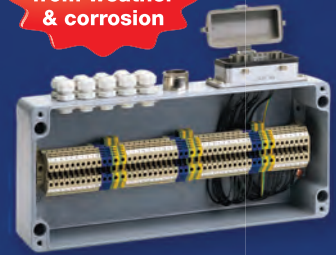

Metric Knockouts



ABOX SERIES

- 6 types
- Modern design and shape that allow for optimum use of installation space
- IP65 protection
- 2 to 4 high grade self tapping screws secure the lid
- Tongue and groove sealing system with polyurethane gasket
- Made from non-flammable Polystyrene

80 x 80 x 52 to 250 x 250 x 115 mm
3.15 x 3.15 x 2.05 to 9.84 x 9.84 x 4.53 in



EK SERIES

- Direct mount
- Small to medium size
- Polycarbonate base and cover
- Integral seals
- Dust and moisture proof
- IP65 protection (NEMA Type 4X)
- High mechanical strength
- Corrosion and maintenance free
- Halogen free

130 x 94 x 80 to 361 x 254 x 110 mm
5.12 x 3.70 x 3.15 to 14.21 x 10.0 x 4.33 in

Protect IEC Components



Smooth exterior walls



AKL SERIES

- Knockout patterns are on the inside, with identical tops and bottoms.
- Up to IP65 protection
- Corrosion and maintenance free
- Polystyrene or Polycarbonate base and cover
- Polycarbonate transparent doors
- Integral seals • Halogen free
- High mechanical strength

150 x 300 x 132 to 600 x 300 x 210 mm
5.91 x 11.81 x 5.20 to 23.62 x 11.81 x 8.27 in



PB SERIES

- IP66
- Universal fit for 22.5 mm diameter push buttons
- Compatible with the EK and TK Enclosure Series
- Metric knockout sidewalls
- Black cover screws are standard with all models
- UV, weather and impact resistant
- Modern, rugged enclosures made of glass fiber reinforced Polycarbonate

94 x 94 x 81 to 180 x 94 x 81 mm
3.70 x 3.70 x 3.19 to 7.09 x 3.70 x 3.19 in

Find your enclosure @
Altech
ENCLOSURE
FINDER

STRAIN RELIEFS, ENCLOSURES & ACCESSORIES

Liquid Tight Strain Reliefs

- Full line of LiquidTight Strain Reliefs (Cord Grips)
- Standard and Industrial Series
- Available in polyamide, nickel-plated brass and stainless steel
- Straight-through, strain relief, bend protection, pull/bend protection, flat cable, multi-conductor and EMI/RFI functions
- Compatible with almost any type of cable, cord or conductor
- Available in PG, Metric and NPT thread sizes



Corrugated Tubes

- Material: Polyamide 6
- Flame retardant according to DIN 75200 and UL
- No halogen
- Durable
- Temperature Range: -40 to 120°C, short term 150°C
- Connectors, Seal Rings, O-Rings, Mounting Clips
- Various Sizes Available



35.5

Widest Selection Available



DIN Enclosures

- Protect electrical, electronic and electromechanical devices with any of seven DIN Enclosure series
- Up to 144 ready-to-wire terminals, integral PC Board guides and terminal-to-board connector options
- Fixed and pluggable terminal options
- DIN Rail or optional panel mount
- In-Rail Bus System
- Custom imprints, markings and cut outs available

57.9

60.4

Suspension Systems

- Modular Design
- Aluminum and Steel Constructions
- Light Duty (up to 99 lbs.)
- Medium Duty (up to 275 lbs.)
- Heavy Duty (up to 330 lbs.)
- Special Stainless Steel Tubing



SWITCHES

22 and 30 mm Push Buttons



Competitively Priced

Large Selection of Push Button Enclosures

22 & 30 mm Push Buttons & Selector Switches

Altech 22 and 30 mm Push Buttons offer ideal cost-effective solutions for control circuits utilizing both direct and remote management applications. Ease of assembly has been engineered into the design; the only tool necessary for installation is a screwdriver.

- Metallic Push Buttons, Selector Switches and LED Pilot Lights
- Designs include Operators, Pilot Lights, Modular Contact Blocks and Bulb Holders
- Push Button Stations
- Wide range of accessories
- 22 mm Series is 100% compatible with another company's XB-2 and ZB-2 series
- Plastic models available
- LED Indicating Devices
- Pilot Lights
- Push Button Enclosures
- UL Recognized
- Custom Push Button Assemblies



Large Variety of Foot Switches



NEW DESIGN & BASES

CUSTOM DESIGNS

ATEX APPROVALS AVAILABLE

Internationally approved Foot Switches accommodate demanding industrial and medical applications. They can be easily customized with nameplates, imprints, cord sets, connectors and strain reliefs.

Foot Switches

- Internationally approved for almost any industrial or medical application.
- Up to three pedals, with or without guards
- IEC 60601-1 certified and UL 2601-1 recognized for all medical applications
- VDE, DIN and CE approvals
- Momentary, maintained and two-stage momentary
- Customized designs available
- Low cost single pedal switch available!



SAFETY SWITCHES

Safety Products for Man and Machine



Keyed Safety Switches

- Monitors the position of hard guarding doors, gates & panels
- Plastic and metal switch bodies in a variety of sizes
- Many different actuation keys available
- Normally Closed and/or Normally Open Contacts
- Switching capacity 240 Volts; 10 AMPS PNP-Output
- B10d up to 2 million cycles
- Protection Rating IP65



New RFID Non Contact Safety Switches

- Safety Rating Cat. 4, PLe, SIL CL3; standalone or in series
- Plug and play M12 connector installation
- PNP or DCD diagnostics
- Common, High or Unique Coding
- 13mm sensing distance
- Local reset available
- Protection Rating IP69



Safety Limit Switches

- Huge range of housing & actuation types
- Switch bodies in plastic or metal
- Normally Closed Positively Opening Contacts
- B10d up to 20 million cycles
- Switching Capacity 240 Volts; 10 AMPS
- Protection Rating IP65

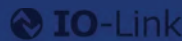

Solenoid Locking Safety Switches

- For locking hard guarding doors, gates & panels
- Plastic and metal switch bodies in two different sizes
- Many different actuation keys available
- Normally Closed and/or Normally Open Contacts
- Switching capacity 240 Volts; 10 AMPS
- B10d up to 2 million cycles
- Protection Rating IP65



Hinged Door Safety Switches

- Monitors the position of hard guarding doors, gates & panels
- Easy to install and tamper proof
- No alignment or re-alignment necessary
- Actuator free with no mechanical deterioration
- Reliable operation - B10d up to 2 million cycles
- Up to 4NC/2NO contacts per switch
- Protection Rating IP67



Safety Rope Pull Switches

- Plastic and Metal switch bodies
- Quick Fix safety rope mounting system
- Built in reset /emergency stop button
- Clearly visible rope tension indication
- Switching Capacity 240 Volts; 10 AMPS
- Protection Rating IP67

DC POWER SOLUTIONS

High End Power Solutions



NOW with CLASS 2

DIN Rail Power Supplies

- DIN Rail mount
- Large variety
- Wide Power Range (10W-960W)
- Wide Adjustment Range
- Rugged for Industrial Use
- High Efficiency
- Lightweight and compact Design
- Short circuit Protection
- Overvoltage Protection
- Overload Protection
- Over-temperature Protection
- Cooling by free air convection
- UL 508 Listed and/or
- UL 60950-1 recognized
- Worldwide approvals
- 3 year warranty



Battery Chargers and DC-UPS Solutions



ALL-IN-ONE DC-UPS

BATTERY CHARGER



Ultra Capacitor DC-UPS



All-In-One DC-UPS

- Power supply, battery charger, battery care module and backup module in one device
- Three charging modes
- Available in 12VDC, 24VDC and 48VDC
- Adjustable charging current up to 35A
- Easy battery diagnosis and fault identification either by LED or external devices connected to fault
- High efficiency up to 91% via switching technology

Ultra Capacitor DC-UPS

- Environmentally safe
- No toxic chemicals
- Virtually maintenance free
- Operating temperature range -40°C to +65°C
- Higher energy vs. electrolytic capacitors
- 12, 24V or 48V DC system design
- AKKUTEC - Battery Back-Up
- Up to 10,000 Ws energy plus extension modules
- Customized systems up to 600A available
- Resists shock and vibration

RELAYS & TIMERS

Wide Range of Relays



Safety Relays

- Feature forced-guided contacts
- Broadest line of Safety Relays that meet the ASME requirements
- Relays meet 2006/42/EC requirements
- IEC / EN 60204, IEC/EN 62061 and DIN/VDE 0113
- Available from 2-8 contacts, 6-10A, 5-220V DC coils
- Applications include emergency stop, two-hand safety, railroad signaling and elevator/escalators.

Relays Modules

- Electronic modules and carriers.
- DIN mountable module
- Connector to terminal blocks
- Relay Modules & Safety Relay Modules
- Diode Modules
- Component Carrier Modules
- I/O opto Carriers
- Custom Designed Modules for any size order
- Quick Delivery

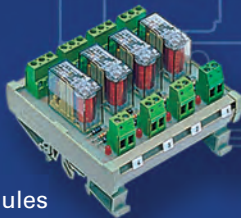

Solid State Relays

- Single, Two and Three Phases
- Solid State Relays for Motor Control
- 1ms on and off times
- 100kA UL SCCR approved
- Produce less electrical interference
- Construction designed to increase lifetime
- Runs silently
- Vibration proof
- IP20 Touch Protection
- Phase Angle Controllers
- DC Solid State Relays
- Heatsinks
- Accessories
- Special Relays / Special Customer Products



Smart Relays

- Supports up to 48 I/Os (32 digital inputs & 16 digital outputs)
- DST Feature Available
- Backlit LCD Screen for display & modification of pre-selected parameters of functional blocks, viewing I/O status and programming on the device
- PC software for programming, online & offline simulation, documentation & printing
- Designed for use in automation for commercial & Industrial sectors
- Modbus Communication



Industrial Relays



- Industrial Electromagnetic Relays
- Miniature Electromagnetic Relays
- Slimline Interface Relays
- Sub-miniature Electromagnetic and Solid State Modules
- Relays for Photovoltaic
- Relay Socket Combination
- Accessories



Slim Line Relays



- Only 6.2mm thick
- Slim DIN Rail mountable interface solution
- Modules have a plug in construction
- Modules available with solid state or mechanical relay
- Built in LED indicates the relay energizing state
- The relay features a SPDT configuration and a maximum switching current of 6A
- Coil voltages from 5VAC/DC up to 230V AC/DC
- Pluggable jumpers available



Digital Timers

- Universal Digital Multi-Timer
- Universal Voltage 24~265 V AC/ DC
- Wide Time Range: 0.1s ~ 999h
- 3 Digit LCD Display for Preset Time and Run Time
- DIN Rail Mounted
- 17.5mm Width
- 8A Relay Output
- Universal Multi-Timer
- Programmable Panel-Mount Digital Multi-Timer
- Digital Time Switch



SENSORS

Superior Sensor Technology

CE



Inductive Proximity Sensors

- Cylindrical, Limit, Block and Ring Sensors
- Standard and analog models
- Standard and extended sensing distance
- Sensitivity as low as 0.15mm steel ball
- Mini, Normal, Analog, High and Ultra High sensitivity ring models
- Modular flat packs for conveyor belt sensing
- Unique metal separation systems available

Specialty Sensors

- AS-i Safe Intelligent
- Inductive
- Capacitive
- Optical
- Ultrasonic
- Magnetic
- Slot
- Float

Metal Detection Systems & Ring Sensors



FUNNEL SYSTEMS

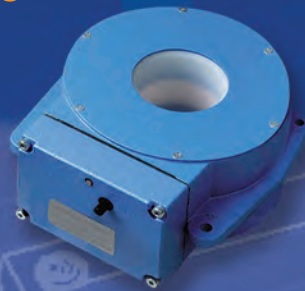

Typical applications includes:
Food and grain
Baking industry
Plastic and rubber regrind
Wood grinding
Semi-finished and finished products

Ring sensors are used for variety of applications including punching and stamping operations to detect small metal parts and for the identification of metallic contamination in bulk materials.



TUNNEL SENSOR



FLAT SENSOR



PANEL ACCESSORIES

New Large Line



Process Controllers

- Temperature Controllers
- Earth Leakage Relays
- Voltage Protection Relays
- Current Protection Relays
- Process Indicators
- Timers



Digital Panel Meters

- Multi Function Meters
- Ampere Meters
- Voltage Meters
- Frequency Meter
- Power Factor Meter
- Disconnect and Test Terminal Block



Mechanical Thermostats

- Adjustable Temperature Control
- Wide Adjustment Range
- Color Coded Dial
(Red: Heating, Blue: Cooling)
- DIN Rail Mountable



Wire Duct

- Exceptional wire protection
- Non-slip interlocking covers
- High impact, rigid PVC construction
- Unslotted, standard slotted or thin slotted models
- Sizes range from 1x1.5 in. to 5x3 in.
- Noryl material also available
- Grey, white, blue and black available
- Covers shipped complete with wire duct

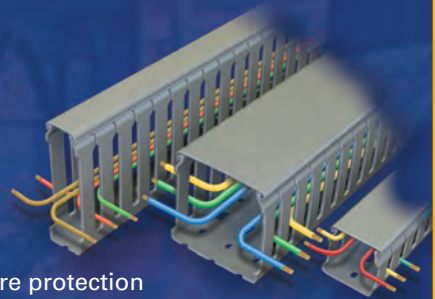

Tower Lights

- Sleek & Stackable Design
- SMD LED Technology
- Uniform & Bright Illumination
- Continuous, Flashing and Rotary Integrated LED Light Modules Available
- Flexibility to upgrade from Single LED Unit to multiple LED Units
- IP65 protection | Wide voltage range from 24V AC/DC to 240V AC
- Optional feature of Buzzer with dual sound mode - continuous & intermittent with 80 DB output



Pin & Sleeve Devices / Receptacles

- Large selection
- IEC 60309 certified power plugs and connectors.
- Electrical rating up to 30A/600V AC
- IEC styles up to 125A/690V AC
- Designs include plugs, receptacles, inlets and connectors
- Splash proof and watertight versions
- Exceptional anti-tracking properties
- Designed for industrial use



ACCESSORIES AND ASSEMBLIES

Test & Measurement

- Size range of 0.64 mm to 4 mm
- Clamp-type test probes
- Alligator clips
- Test probes
- Oscilloscope
- Measuring leads
- Plugs
- Sockets
- Sets



Marking Systems

- Compatible for terminal block markers and wire markers such as Altech Corp, Allen Bradley, Connectwell, Conta Clip, Entrelec, Weidmueller, Phoenix Contact, PTR, Wieland, Wago, Murrplastik, Partex, SES, Sterling, etc.
- Engravers for plastic signs, legend plates, inlays, etc.
- Plotter pens (0.18 - 1.00 mm)
- Ink for plastic material and general use
- Pen cleaners, Fixtures, Software
- Service and repair available from Altech



Custom Assemblies

Application Assistance

- Modify a standard product
- Help define a new product

Engineering Capability

- Use of latest CAD system
- PCB layouts completed promptly
- Prototypes available two weeks after PCB layout approval

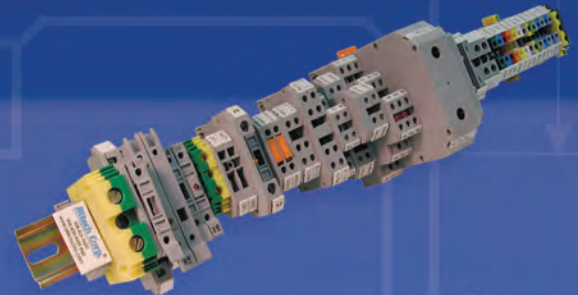

Minimum Quantities

- 25 piece minimum for custom quotes
- Quotation provided at no cost

Altech Benefits

- Fast turnaround due to in-house capability
- Highly competitive in-house manufacturing
- Use of Altech components (blocks, extrusions, connectors)

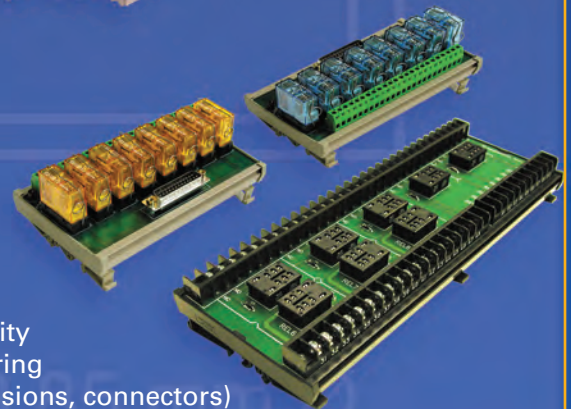

Altech Search

Google

Home Stock Check Distributors Information News Contact Rep/Dist Login Altech Mexico

WEB TOOLS

- Drawings & Photos
- Enclosure Finder
- Altech Videos
- Request for Quote
- Sample Request
- Catalog Request
- Product Crossings
- eBook Catalog

PRODUCT MENU

- ATEX Products
- Circuit Protection/Control >
- Connectors >
- Enclosures >
- Fuses >
- Digital Panel Meters
- Foot Switches
- Interface Modules >
- Panel Accessories
- Power Supplies
- Power Semi-Conductors
- PCB Connection Technology >
- Programmable Controllers
- Push Buttons & Pilot Lights >
- Relays >
- Sensors >
- Safety Switches >
- Standard Switches >
- Solid State Relays
- Terminal Blocks >
- Test & Measurement

New Products and Promotions

The NEW

Altech ENCLOSURE FINDER



Click here to begin

CIRCUIT PROTECTION

 Circuit Protection Devices	 Busbar & Power Distribution	 Contactors, Overload Relays, Manual Motor Starters	 Motor Disconnect Switches	 European Fuses & Holders
--	---	--	---	--

CONNECTORS

 Pin & Sleeve Devices	 Receptacles
---	--

ENCLOSURES

 Industrial & ATEX Enclosures	 DIN Enclosures	 Control Enclosures and Suspension Systems
---	---	--

FOOT SWITCHES

 Industrial	 Medical
--	---

MODULES & RELAYS

 Interface Modules	 Safety Relays	 Industrial & Slimline Relays
---	---	--

PANEL ACCESSORIES

 Panel Lights	 Heaters, Filters & Thermostats
--	--

SPARE PARTS

 European Spare Parts
--

PILOT DEVICES

 22 & 30 mm Push Buttons & Enclosures	 Pilot Lights & E-Stops
--	--





POWER DEVICES

 Power Supplies	 DC-UPS & Battery Chargers
--	---

POWER MANAGEMENT

 Altech Smart Relays	 Digital Panel Meters	 Digital Timers
---	--	--

SAFETY SWITCHES

 Keyed Safety Switches	 Keyed Solenoid Locking Switches	 Hinged Safety Switches	 Non-Contact Safety Switches	 Safety Rope Pull Switches
---	---	--	---	---

STANDARD SWITCHES

 Standard Switches

SENSORS

 Sensors

Altech Corporation
35 Royal Road
Flemington, NJ 08822-6000
P 908.806.9400 • F 908.806.9490
www.altechcorp.com

