

Altech Corp.®

Serving the Automation & Control Industry since 1984



ISO 9001
CMI-SAI Global

Current Limiting



UL 508 Manual Motor Controllers

UL 489 Miniature Molded Case Circuit Breakers

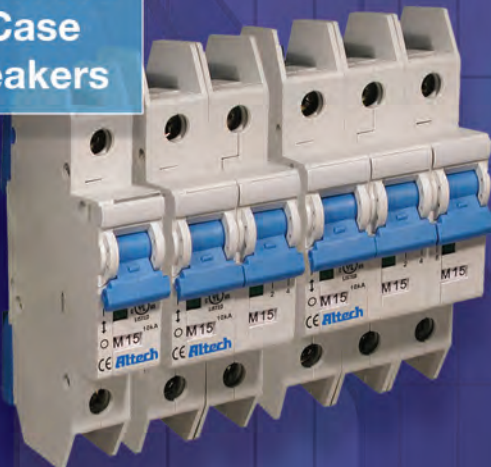

UL 1077 Supplementary Protector



UL 489, UL 508 and UL 1077 Busbar Devices



Circuit Protection Products

Altech Corp.®

Since 1984, Altech Corporation has grown to become a leading supplier of automation and industrial control components. Headquartered in Flemington, NJ, Altech has an experienced staff of engineering, manufacturing and sales personnel to provide the highest quality products with superior service. This is the Altech Commitment!

With experienced Product Engineers and Customer Service personnel, Altech provides solutions to your most pressing application challenges. All with one thought in mind - *to ensure that we solve your problem the first time!*

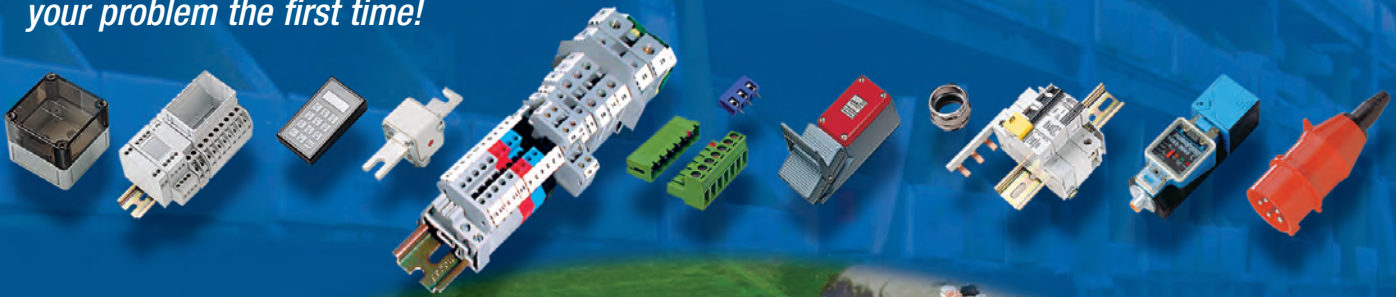

Quality Commitment

Altech's control components meet diverse national and international standards such as UL, NEC, CSA, IEC, VDE and more. Altech provides superior customer service and delivery through Total Quality Management and Continuous Process Improvement. Altech is ISO 9001 approved. We perform these services with honesty and integrity and are committed to achieve these goals.



The Altech Selection of Breakers	4-5
Application Examples UL508A	6-9
UL489 Miniature Molded Case Circuit Breakers	
UL (AC), DL (DC) Series	
• UL489 Miniature Molded Case Circuit Breaker.....	10-11
• C Trip Characteristic AC	12
• D Trip Characteristic AC	13
• C Trip Characteristic DC	14
• D Trip Characteristic DC	15
• Accessories for UL/DL Series	16
• Trip Curves and Technical Data	17-19
L (AC or DC) Series	
• UL489 Miniature Molded Case Circuit Breaker.....	20-21
• C Trip Characteristic AC	22
• D Trip Characteristic AC	23
• C and D Trip Characteristics DC	24
• Trip Curves and Technical Data.....	25
• Accessories for L Series	26-27
UL489 Busbar System	
• Introduction and Ordering Information	28-35
UL508 Manual Motor Controllers “Suitable as Motor Disconnect”	
UM (V-EA) Series	
• UL508 Manual Motor Controllers “Suitable as Motor Disconnect”.....	36-37
• B Trip Characteristic	38
• C Trip Characteristic	39
• D Trip Characteristic	40
• E Trip Characteristic	41
• G Trip Characteristic	42
• Z Trip Characteristic.....	43
• Trip Curves and Technical Data	44-47
MA Series	
• Three Phase Adjustable Trip Miniature Circuit Breakers/Manual Motor Controllers.....	48-49
• Accessories V-EA/MA Series	50-51
MS Series	
• Three Phase Adjustable Trip Economy Manual Motor Controllers.....	52
• Accessories MS Series	53
UL1077 Supplementary Protectors	
UR Series	
• UL1077 Supplementary Protectors.....	54-55
• B Trip Characteristic	56
• C Trip Characteristic	57
• D Trip Characteristic	58
• Accessories UR Series	59
• Trip Curves and Technical Data	60-61
R Series	
• UL1077 Supplementary Protectors.....	62-63
• B Trip Characteristic	64
• C Trip Characteristic	65
• D Trip Characteristic	66
• Trip Curves and Technical Data.....	67
• Accessories UR Series	68-69
UL1077 / UL508 Busbar System	
• Introduction and Ordering Information	70-79
TR Series UL1077 Recognized Supplementary Protector /Circuit Breaker for Equipment	80-85
RP Series RCCB Earth Leakage Circuit Breaker	86-87
Index	88-93
Terms and Conditions	94

UL 489

UL 508

UL 1077

UL 1077
Equipment Breakers

Earth Leakage
Circuit Breakers

ANNEX

The Altech Selection of Breakers

UL 489

UL 508

UL 1077

UL 1077
Equipment Breakers

Earth Leakage
Circuit Breakers

ANNEX

The Advantages

In today's very competitive marketplace you need reliability, so you need to use circuit breakers that are high quality and technically correct for your application. Altech is a US leader in DIN rail mounted breakers with ratings up to 63A. Only Altech offers DIN rail mounted breakers that meet UL489, UL508 or UL1077 approvals with a short circuit interrupt capacity of up to 10kA. No other manufacturer offers this complete line. This assures you the right product for your application requirements.

UL (AC), DL (DC), V-EA and UR Series Advantages

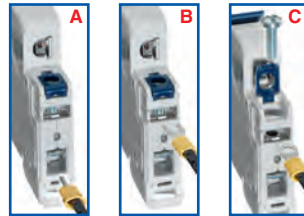

Unique Standard Dual Connection Terminals

- A Box terminal for solid conductors or flexible conductors with or without cable lug.
- B Screw terminal for forked cable lug.
- C Screw terminal for ring tongue connection.

L and R Series Advantages



- ON
- OFF



D15

UL 489

UL (AC), DL (DC) Series UL489 Miniature Molded Case Circuit Breakers



ACCESSORIES

- Auxiliary Contact, Alarm Switch
- Shunt Trip
- Neutral Pole
- Undervoltage Trip (not UL)
- Touch Protection Caps
- Cooling Spacer
- Mounting Screw 34mm
- Lock-out Adapter

L Series, AC or DC UL489 Miniature Molded Case Circuit Breakers

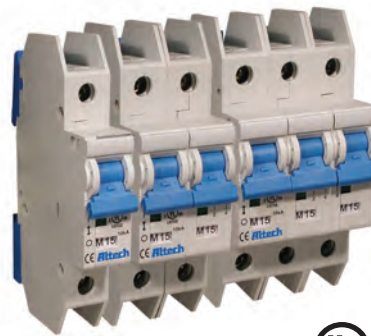

ACCESSORIES

- Auxiliary Contact
- Shunt Trip
- Neutral Pole
- Undervoltage Trip
- Front Mounting Kit with hardware
- Lock-out Adapter

UL 508

UM (V-EA) Series UL508 Manual Motor Controllers
 “Suitable as Motor Disconnect”



ACCESSORIES

- Auxiliary Contact, Alarm Switch
- Shunt Trip
- Undervoltage Trip (not UL)
- Neutral Pole
- Touch Protection Caps
- Cooling Spacer
- Mounting Screw 34mm
- Lock-out Adapter**

UL 1077

UR Series UL1077 Recognized Supplementary Protector



ACCESSORIES

- Auxiliary Contact, Alarm Switch
- Shunt Trip
- Undervoltage Trip (not UL)
- Neutral Pole
- Touch Protection Caps
- Cooling Spacer
- Mounting Screw 34mm
- Lock-out Adapter

R Series UL1077 Recognized Supplementary Protector



ACCESSORIES

- Auxiliary Contact
- Shunt Trip and Undervoltage Trip (not UL)
- Neutral Pole
- Lock-out Adapter

2 series, 5 lines, 3 UL approvals, AC and DC models and the most trip curves in the industry.

Altech has the broadest offering in the industry.

UL 489

UL 508

UL 1077

UL 1077
Equipment Breakers

Earth Leakage
Circuit Breakers

ANNEX

Typical UL508A Panel

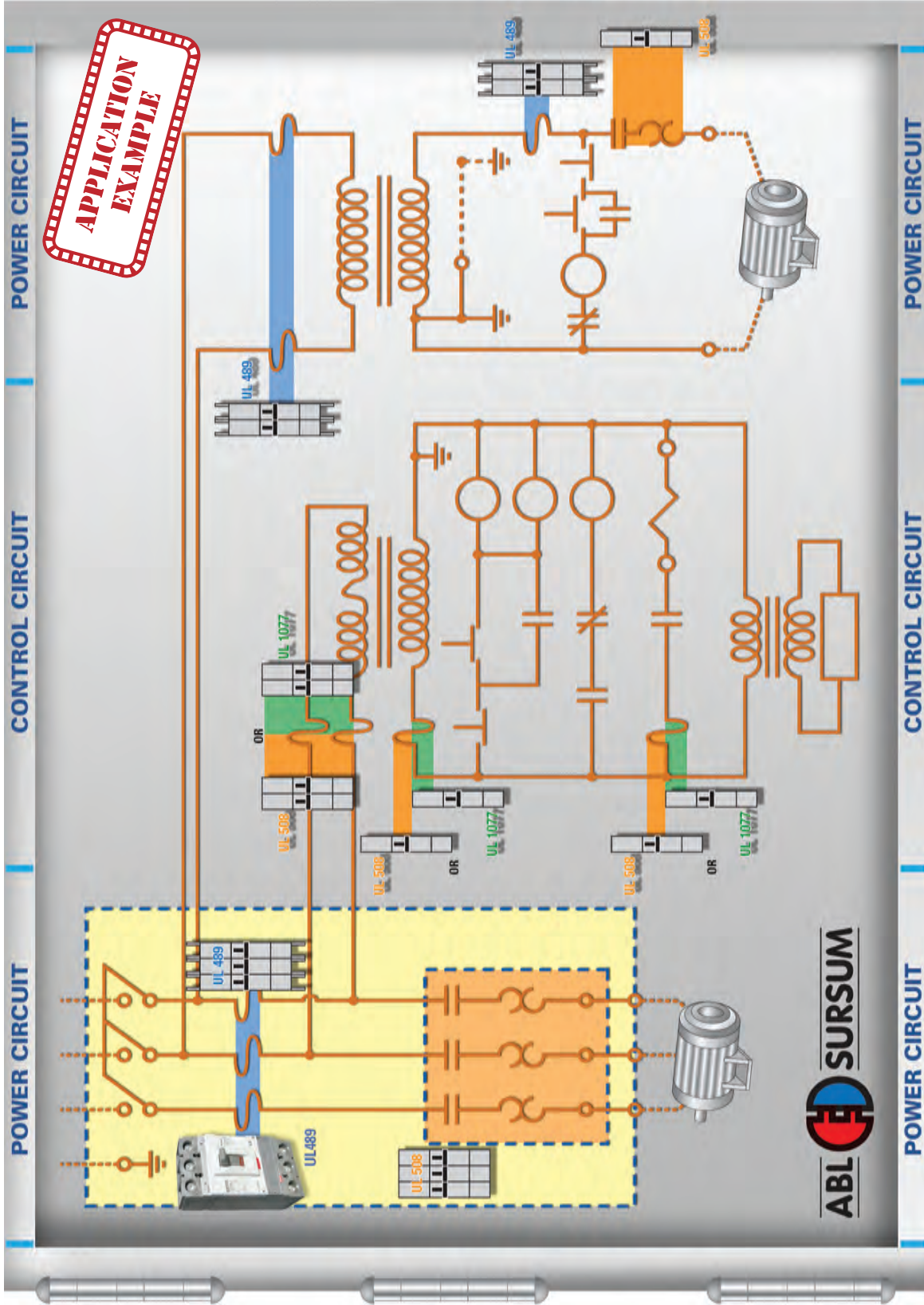

Disclaimer: This is an application example. Installation should be done by a qualified electrician under the guidance of UL/NEC® specifications.

Variation of UL508A Panel

(see NEC® article 430.53 for reference and more information).

APPLICATION EXAMPLE

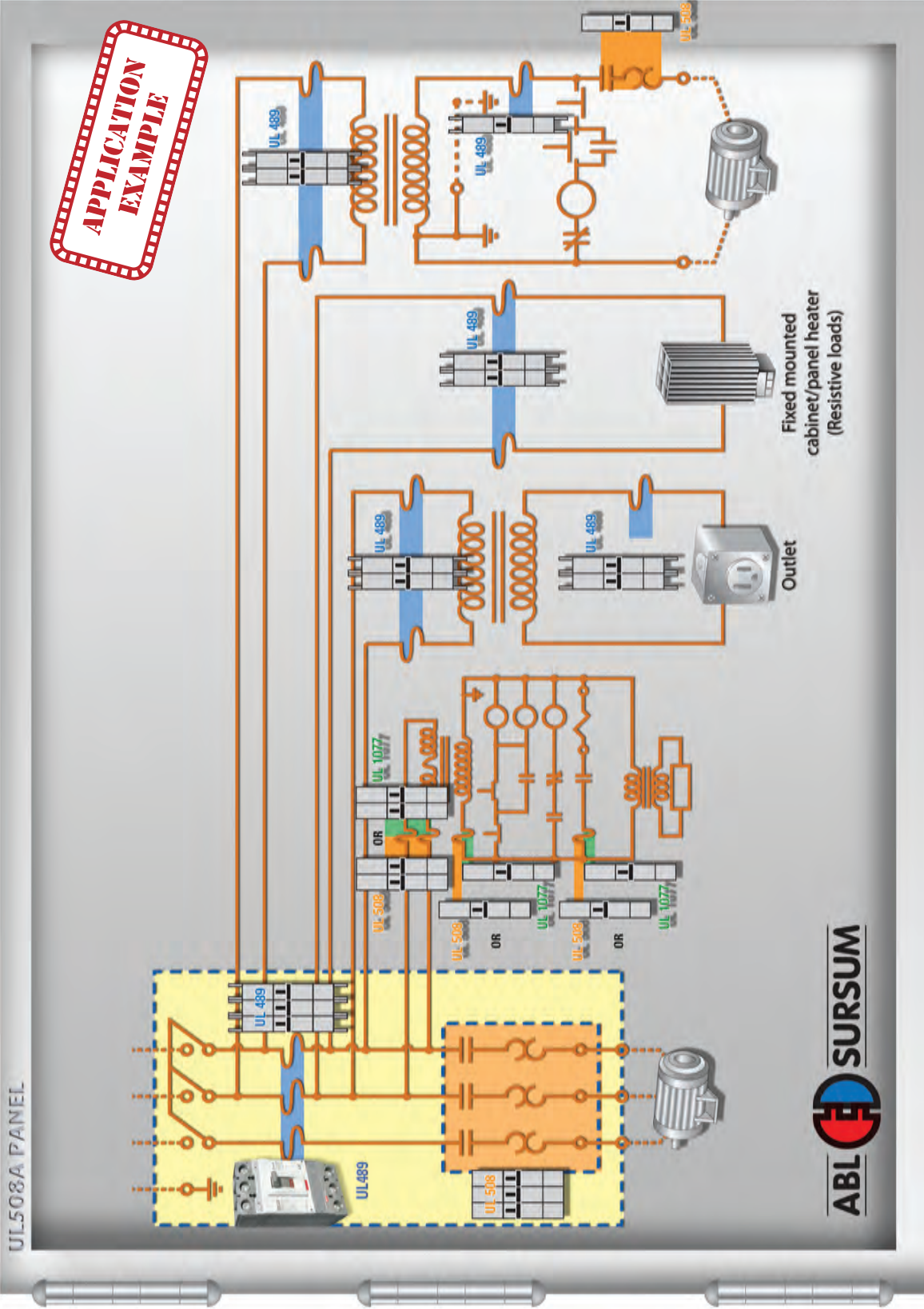

Disclaimer: This is an application example. Installation should be done by a qualified electrician under the guidance of UL/NEC® specifications.

UL 489

UL 508

UL 1077

UL 1077
Equipment Breakers

Earth Leakage
Circuit Breakers

ANNEX

Typical Motor Group Installation

(see NEC® article 430.53 for reference and more information).

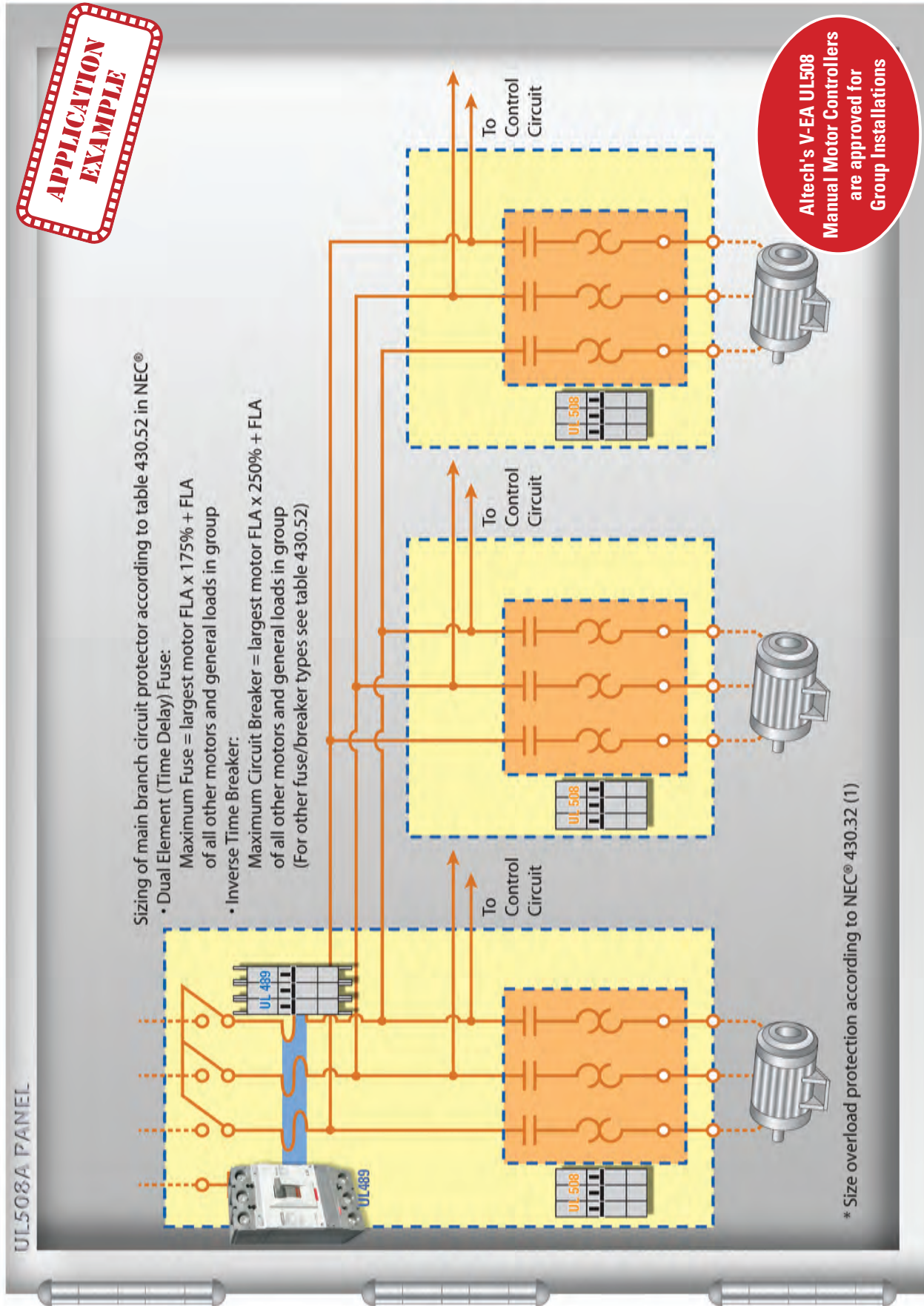

Disclaimer: This is an application example. Installation should be done by a qualified electrician under the guidance of UL/NEC® specifications.

UL(AC), DL(DC) Series

UL489 Miniature Molded Case Circuit Breakers

- Available in AC and DC models
- DIN Rail Mounted
- 17.5mm width
- Thermal Magnetic
- Current Limiting (UL tested)
- 240V, 480Y/277V AC, 50/60Hz
- 125V DC (1 pole); 250V DC (2 pole)
- 10kA Short Circuit Interrupting Capacity
- HACR Type 40°C
- Line/Load reversible

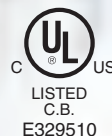

IEC 60947-2
Short Circuit Tested

Current/ Voltage Rating

UL-Series 0.3 - 63A/ 240V AC, 0.3-32A/ 480Y/277V AC* (48V DC / pole pending)

DL-Series 0.3 - 63A/ 125/ 250V DC

Calibration Temperature 40°C (104°F)

Ambient Temperature -25°C to +55°C (-13°F to 131°F)

Storage Temperature -40°C to +70°C (-40°F to 158°F)

Terminal Size Acceptability Top: 18-3 AWG; Bottom: 18-2 AWG

Terminal Torque (min/max) 2 Nm (17.7 lb.in.) / 2.5Nm (22.2 lb.in)

Electrical Life 6,000 switching cycles ON/ OFF

Mechanical Life 10,000 switching cycles ON/ OFF

Vibration Resistance > 15g according to DIN EN 60069-2-59 during a load with $I_1 = 1.05 \times I_N$

Resistance to mechanical shocks 25g @ 11ms

Degree of protection acc. IEC/EN 60529 IP20

Mounting Orientation In any plane

*One device, dual voltage ratings.

Short Circuit Interrupting Capacity According to UL 489

No. Poles	Type	0.3-32A	40-63A
1	AC	10kA @ 120, 240, 277V	10kA @ 120, 240V
2-3	AC	10kA @ 120, 240, 480Y/277V	10kA @ 120 240V

No. Poles	Type	0.3-32A	40-63A
1	DC	10kA @ 125V	10kA @ 125V
2	DC	10kA @ 250V	10kA @ 250V

Short Circuit Interrupting Capacity According to IEC 60947-2, DIN EN 60947-2

No. Poles	Type	0.3-32	40-63A
1	AC	15kA@240V	15kA@240V
2-3	AC	15kA@415V	10kA@415V

Marking Details



Dimensions in mm

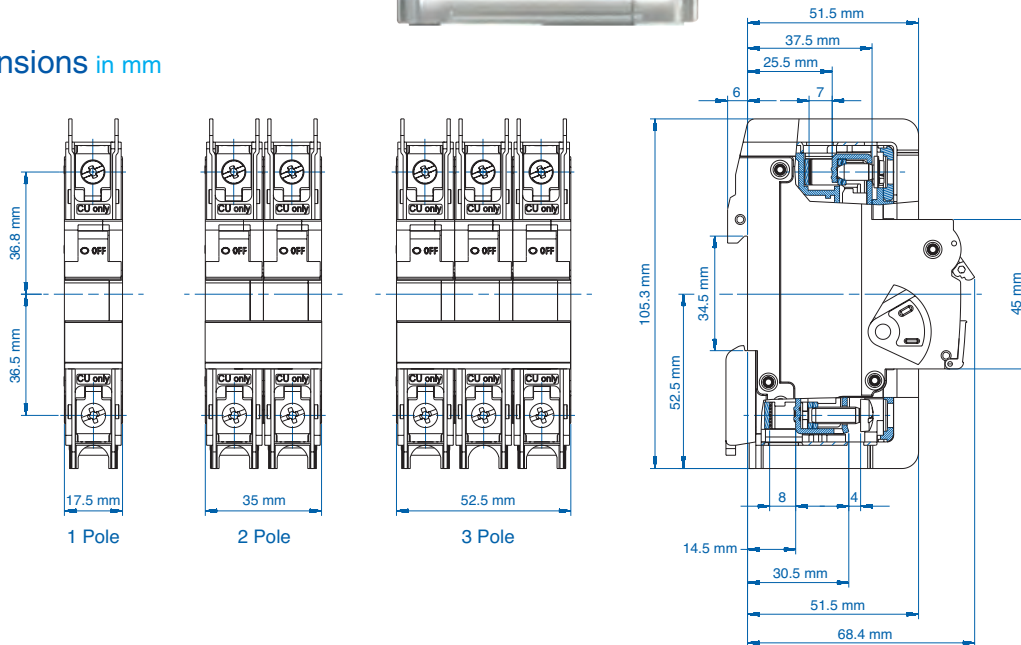

Trip-Characteristics*				Applications								
Characteristic Trip Boundaries				Lighting Wiring Protection Control Circuits	Business Equipment Appliances	Transformers	Power Supplies Heaters	Motors		Reactive Load	Telecommu- nications/ Computer Equipment	Power Supplies
Thermal Trip		Magnetic Trip						Low Inrush	High Inrush			
Must not Trip>100ms	Must Trip <1hr	Must not Trip>100ms	Must Trip at 100ms									
C-Characteristics AC												
1.05xRC	1.35xRC	5xRC	10xRC									
C-Characteristics DC												
1.05xRC	1.35xRC	7xRC	14xRC									
D-Characteristics AC												
1.05xRC	1.35xRC	10xRC	16xRC									
D-Characteristics DC												
1.05xRC	1.35xRC	14xRC	22.4xRC									

*The value of each characteristic is shown vertically beneath its corresponding heading.



Warning!

This information should only be used as a selection guide. The use of a Miniature Circuit Breaker in an application with a certain Trip-Characteristic always requires prototype testing! It is the responsibility of the circuit design engineer to select the appropriate Miniature Circuit Breaker for his specific application.

UL 489

UL 508

UL 1077

UL 1077
Equipment Breakers

Earth Leakage
Circuit Breakers

ANNEX

UL - Series

C-Trip

Characteristic



E329510

Application Examples:

Low inrush motors, resistive loads, wiring protection, receptacles, lighting, and control circuit applications. Relatively short thermal trip delay and medium magnetic trip point.



One Pole

Rated Current	Type/ Cat. No.	Rated Voltage
0.3A	1C03UL	277V AC
0.5A	1C05UL	277V AC
1.0A	1C1UL	277V AC
1.6A	1C1.6UL	277V AC
2.0A	1C2UL	277V AC
3.0A	1C3UL	277V AC
4.0A	1C4UL	277V AC
5.0A	1C5UL	277V AC
6.0A	1C6UL	277V AC
8.0A	1C8UL	277V AC
10A	1C10UL	277V AC
12A	1C12UL	277V AC
13A	1C13UL	277V AC
15A	1C15UL	277V AC
16A	1C16UL	277V AC
20A	1C20UL	277V AC
25A	1C25UL	277V AC
30A	1C30UL	277V AC
32A	1C32UL	277V AC
40A	1C40UL	240V AC
50A	1C50UL	240V AC
60A	1C60UL	240V AC
63A	1C63UL	240V AC

Standard Pack: 12

Weight:
0.3-32A:
1.74kg (3.83lb.)

40-63A:
1.98kg (4.37lb.)



Three Pole

Rated Current	Type/ Cat. No.	Rated Voltage
0.3A	3C03UL	480Y/277V AC
0.5A	3C05UL	480Y/277V AC
1.0A	3C1UL	480Y/277V AC
1.6A	3C1.6UL	480Y/277V AC
2.0A	3C2UL	480Y/277V AC
3.0A	3C3UL	480Y/277V AC
4.0A	3C4UL	480Y/277V AC
5.0A	3C5UL	480Y/277V AC
6.0A	3C6UL	480Y/277V AC
8.0A	3C8UL	480Y/277V AC
10A	3C10UL	480Y/277V AC
12A	3C12UL	480Y/277V AC
13A	3C13UL	480Y/277V AC
15A	3C15UL	480Y/277V AC
16A	3C16UL	480Y/277V AC
20A	3C20UL	480Y/277V AC
25A	3C25UL	480Y/277V AC
30A	3C30UL	480Y/277V AC
32A	3C32UL	480Y/277V AC
40A	3C40UL	240V AC
50A	3C50UL	240V AC
60A	3C60UL	240V AC
63A	3C63UL	240V AC

Standard Pack: 4

Weight:
0.3-32A:
1.74kg (3.83lb.)

40-63A:
1.98kg (4.37lb.)



Two Pole

Rated Current	Type/ Cat. No.	Rated Voltage
0.3A	2C03UL	480Y/277V AC
0.5A	2C05UL	480Y/277V AC
1.0A	2C1UL	480Y/277V AC
1.6A	2C1.6UL	480Y/277V AC
2.0A	2C2UL	480Y/277V AC
3.0A	2C3UL	480Y/277V AC
4.0A	2C4UL	480Y/277V AC
5.0A	2C5UL	480Y/277V AC
6.0A	2C6UL	480Y/277V AC
8.0A	2C8UL	480Y/277V AC
10A	2C10UL	480Y/277V AC
12A	2C12UL	480Y/277V AC
13A	2C13UL	480Y/277V AC
15A	2C15UL	480Y/277V AC
16A	2C16UL	480Y/277V AC
20A	2C20UL	480Y/277V AC
25A	2C25UL	480Y/277V AC
30A	2C30UL	480Y/277V AC
32A	2C32UL	480Y/277V AC
40A	2C40UL	240V AC
50A	2C50UL	240V AC
60A	2C60UL	240V AC
63A	2C63UL	240V AC

Standard Pack: 6

Weight:
0.3-32A:
1.74kg (3.83lb.)

40-63A:
1.98kg (4.37lb.)



Add-on Neutral Pole

Rated Current	Type/ Cat. No.	Rated Voltage
0.3-32A	N32UL	480Y/277V AC
40-63A	N63UL	240V AC

Standard Pack: 6

Weight:
0.99kg (2.18 lb.)

Standard Dual Connection Terminal

- Box clamp terminals
Top: 18-3 AWG;
Bottom: 18-2 AWG
(Line/Load reversible)
- Ring tongue terminals

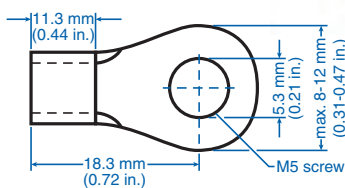
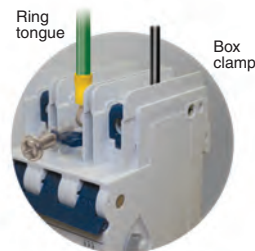

* May differ by manufacturer. Top terminal ring tongue max. thickness 1.6mm.

UL - Series D-Trip Characteristic



E329510

Application Examples:

High inrush motors, transformers, power supplies, heaters and reactive loads. Relatively long thermal trip delay and very high magnetic trip point.

One Pole



Rated Current	Type/ Cat. No.	Rated Voltage
0.3A	1D03UL	277V AC
0.5A	1D05UL	277V AC
1.0A	1D1UL	277V AC
1.6A	1D1.6UL	277V AC
2.0A	1D2UL	277V AC
3.0A	1D3UL	277V AC
4.0A	1D4UL	277V AC
5.0A	1D5UL	277V AC
6.0A	1D6UL	277V AC
8.0A	1D8UL	277V AC
10A	1D10UL	277V AC
12A	1D12UL	277V AC
13A	1D13UL	277V AC
15A	1D15UL	277V AC
16A	1D16UL	277V AC
20A	1D20UL	277V AC
25A	1D25UL	277V AC
30A	1D30UL	277V AC
32A	1D32UL	277V AC
40A	1D40UL	240V AC
50A	1D50UL	240V AC
60A	1D60UL	240V AC
63A	1D63UL	240V AC

Standard Pack: 12

Weight:
0.3-32A:
1.74kg (3.83lb.)
40-63A:
1.98kg (4.37lb.)



Three Pole

Rated Current	Type/ Cat. No.	Rated Voltage
0.3A	3D03UL	480Y/277V AC
0.5A	3D05UL	480Y/277V AC
1.0A	3D1UL	480Y/277V AC
1.6A	3D1.6UL	480Y/277V AC
2.0A	3D2UL	480Y/277V AC
3.0A	3D3UL	480Y/277V AC
4.0A	3D4UL	480Y/277V AC
5.0A	3D5UL	480Y/277V AC
6.0A	3D6UL	480Y/277V AC
8.0A	3D8UL	480Y/277V AC
10A	3D10UL	480Y/277V AC
12A	3D12UL	480Y/277V AC
13A	3D13UL	480Y/277V AC
15A	3D15UL	480Y/277V AC
16A	3D16UL	480Y/277V AC
20A	3D20UL	480Y/277V AC
25A	3D25UL	480Y/277V AC
30A	3D30UL	480Y/277V AC
32A	3D32UL	480Y/277V AC
40A	3D40UL	240V AC
50A	3D50UL	240V AC
60A	3D60UL	240V AC
63A	3D63UL	240V AC

Standard Pack: 4

Weight:
0.3-32A:
1.74kg (3.83lb.)
40-63A:
1.98kg (4.37lb.)

Two Pole



Rated Current	Type/ Cat. No.	Rated Voltage
0.3A	2D03UL	480Y/277V AC
0.5A	2D05UL	480Y/277V AC
1.0A	2D1UL	480Y/277V AC
1.6A	2D1.6UL	480Y/277V AC
2.0A	2D2UL	480Y/277V AC
3.0A	2D3UL	480Y/277V AC
4.0A	2D4UL	480Y/277V AC
5.0A	2D5UL	480Y/277V AC
6.0A	2D6UL	480Y/277V AC
8.0A	2D8UL	480Y/277V AC
10A	2D10UL	480Y/277V AC
12A	2D12UL	480Y/277V AC
13A	2D13UL	480Y/277V AC
15A	2D15UL	480Y/277V AC
16A	2D16UL	480Y/277V AC
20A	2D20UL	480Y/277V AC
25A	2D25UL	480Y/277V AC
30A	2D30UL	480Y/277V AC
32A	2D32UL	480Y/277V AC
40A	2D40UL	240V AC
50A	2D50UL	240V AC
60A	2D60UL	240V AC
63A	2D63UL	240V AC

Standard Pack: 6

Weight:
0.3-32A:
1.74kg (3.83lb.)
40-63A:
1.98kg (4.37lb.)



Add-on Neutral Pole

Rated Current	Type/ Cat. No.	Rated Voltage
0.3-32A	N32UL	480/277V AC
40-63A	N63UL	240V AC

Standard Pack: 6

Weight:
0.99kg (2.18 lb.)

Standard Dual Connection Terminal

- Box clamp terminals
Top: 18-3 AWG;
Bottom: 18-2 AWG
(Line/Load reversible)
- Ring tongue terminals

Ring tongue

Box clamp

11.3 mm (0.44 in.)

18.3 mm (0.72 in.)

5.3 mm (0.21 in.)

max. 8-12 mm (0.31-0.47 in.)

M5 screw

* May differ by manufacturer. Top terminal ring tongue max. thickness 1.6mm.

UL 489

UL 508

UL 1077

UL 1077
Equipment Breakers

Earth Leakage
Circuit Breakers

ANNEX

UL - Series C-Trip (DC) Characteristic

Application Examples:

Telecommunication equipment,
computer equipment, uninterruptable power supplies.



One Pole



Standard Pack: 12

Weight:
0.3-32A:
1.86kg (4.1lb.)
40-63A:
2.10kg (4.6lb.)

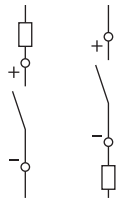

Rated Current	Type/ Cat. No.	Rated Voltage
0.3A	1C03DL	125V DC
0.5A	1C05DL	125V DC
1.0A	1C1DL	125V DC
1.6A	1C1.6DL	125V DC
2.0A	1C2DL	125V DC
3.0A	1C3DL	125V DC
4.0A	1C4DL	125V DC
5.0A	1C5DL	125V DC
6.0A	1C6DL	125V DC
8.0A	1C8DL	125V DC
10A	1C10DL	125V DC
12A	1C12DL	125V DC
13A	1C13DL	125V DC
15A	1C15DL	125V DC
16A	1C16DL	125V DC
20A	1C20DL	125V DC
25A	1C25DL	125V DC
30A	1C30DL	125V DC
32A	1C32DL	125V DC
40A	1C40DL	125V DC
50A	1C50DL	125V DC
60A	1C60DL	125V DC
63A	1C63DL	125V DC

Two Pole



Standard Pack: 6

Weight:
0.3-32A:
1.86kg (4.1lb.)
40-63A:
2.10kg (4.6lb.)

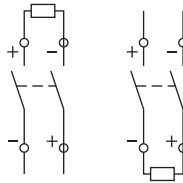

Rated Current	Type/ Cat. No.	Rated Voltage
0.3A	2C03DL	250V DC
0.5A	2C05DL	250V DC
1.0A	2C1DL	250V DC
1.6A	2C1.6DL	250V DC
2.0A	2C2DL	250V DC
3.0A	2C3DL	250V DC
4.0A	2C4DL	250V DC
5.0A	2C5DL	250V DC
6.0A	2C6DL	250V DC
8.0A	2C8DL	250V DC
10A	2C10DL	250V DC
12A	2C12DL	250V DC
13A	2C13DL	250V DC
15A	2C15DL	250V DC
16A	2C16DL	250V DC
20A	2C20DL	250V DC
25A	2C25DL	250V DC
30A	2C30DL	250V DC
32A	2C32DL	250V DC
40A	2C40DL	250V DC
50A	2C50DL	250V DC
60A	2C60DL	250V DC
63A	2C63DL	250V DC



Warning!
Correct polarity must be observed
when connecting the DC circuit breakers.



Standard Dual Connection Terminal

- Box clamp terminals
Top: 18-3 AWG;
Bottom: 18-2 AWG
(Line/Load reversible)
- Ring tongue terminals

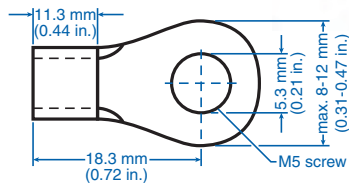
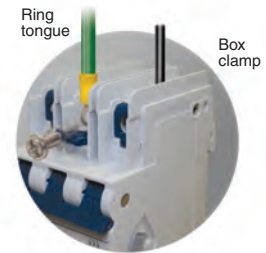

* May differ by manufacturer. Top terminal ring tongue max. thickness 1.6mm.

UL - Series D-Trip (DC) Characteristic

Application Examples:

Telecommunication equipment,
computer equipment, uninterruptable power supplies.



One Pole



Rated Current	Type/ Cat. No.	Rated Voltage
0.3A	1D03DL	125V DC
0.5A	1D05DL	125V DC
1.0A	1D1DL	125V DC
1.6A	1D1.6DL	125V DC
2.0A	1D2DL	125V DC
3.0A	1D3DL	125V DC
4.0A	1D4DL	125V DC
5.0A	1D5DL	125V DC
6.0A	1D6DL	125V DC
8.0A	1D8DL	125V DC
10A	1D10DL	125V DC
12A	1D12DL	125V DC
13A	1D13DL	125V DC
15A	1D15DL	125V DC
16A	1D16DL	125V DC
20A	1D20DL	125V DC
25A	1D25DL	125V DC
30A	1D30DL	125V DC
32A	1D32DL	125V DC
40A	1D40DL	125V DC
50A	1D50DL	125V DC
60A	1D60DL	125V DC
63A	1D63DL	125V DC

Standard Pack: 12

Weight:
0.3-32A:
1.86kg (4.1lb.)
40-63A:
2.10kg (4.6lb.)

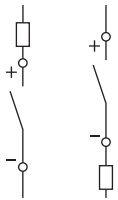

Two Pole



Rated Current	Type/ Cat. No.	Rated Voltage
0.3A	2D03DL	250V DC
0.5A	2D05DL	250V DC
1.0A	2D1DL	250V DC
1.6A	2D1.6DL	250V DC
2.0A	2D2DL	250V DC
3.0A	2D3DL	250V DC
4.0A	2D4DL	250V DC
5.0A	2D5DL	250V DC
6.0A	2D6DL	250V DC
8.0A	2D8DL	250V DC
10A	2D10DL	250V DC
12A	2D12DL	250V DC
13A	2D13DL	250V DC
15A	2D15DL	250V DC
16A	2D16DL	250V DC
20A	2D20DL	250V DC
25A	2D25DL	250V DC
30A	2D30DL	250V DC
32A	2D32DL	250V DC
40A	2D40DL	250V DC
50A	2D50DL	250V DC
60A	2D60DL	250V DC
63A	2D63DL	250V DC

Standard Pack: 6

Weight:
0.3-32A:
1.86kg (4.1lb.)
40-63A:
2.10kg (4.6lb.)

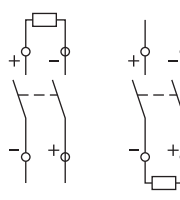

Warning!
Correct polarity must be observed
when connecting the DC circuit breakers.



Standard Dual Connection Terminal

- Box clamp terminals
Top: 18-3 AWG;
Bottom: 18-2 AWG
(Line/Load reversible)
- Ring tongue terminals

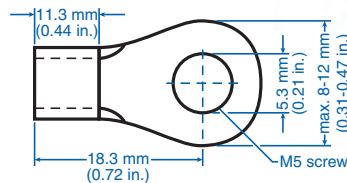
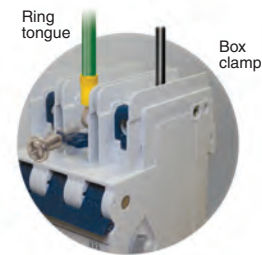

* May differ by manufacturer. Top terminal ring tongue max. thickness 1.6mm.

UL 489

UL 508

UL 1077

UL 1077
Equipment Breakers

Earth Leakage
Circuit Breakers

ANNEX

UL/DL Series Accessories

For mounting instructions please refer to page 43.



Auxiliary Contact, Alarm Switch

Type/ Cat No.	Description	Contacts Type	Std Pk
H10UL	1 Auxiliary Contact	1NO	6
H11UL	2 Auxiliary Contacts	1NO + 1NC	6
H12UL	3 Auxiliary Contacts	1NO + 2NC	6
H21UL	3 Auxiliary Contacts	2NO + 1NC	6
HLS11L*	1 Auxiliary/1 Signal Contact	1CO + 1CO (Signal)	6

Rated Operating Currents	10A@240V AC 3A@110V DC 1A@220V DC
---------------------------------	---

Minimum Contact Load Torque	1mA @ 24V DC max. 0.8Nm (7 lb.in)
------------------------------------	--------------------------------------

Wire Range:	
Single Wire	1.0mm ² - 2.5mm ² (18-14 AWG)
Stranded Wire	1.0mm ² - 1.5mm ² (18-16 AWG)
Stranded Wire with Ferrule	1.0mm ² - 1.5mm ² (18-16 AWG)

Shunt Trip

Type/ Cat No.	Rated Voltage U _N	Max. Operating Current @ U _N	Std Pk
FA12UL	12V AC/DC	1.3A	5
FA24UL	24V AC/DC	0.6A	5
FA48UL	48 - 72V AC/DC	0.2A	5
FA110UL	110 - 240V AC/DC, 277V AC	0.25A @ 110V 0.5A @ 240V 0.58A @ 277V	5

Undervoltage Trip*

Type/ Cat No.	Line Voltage V _E	Std Pk
UA120UL	120V AC, 60Hz	5

Reset-Hold Voltage = 0.85 x V_E
Drop-Out Voltage = 0.35 ~ 0.7 x V_E

V_E = Rated Voltage

Neutral Pole

Type/ Cat No.	Rated Current I _N	Rated Voltage U _N	Std Pk
N32UL	0.3 - 32A	480Y/277V AC	6
N63UL	40 - 63A	240V AC	6

Touch Protection Caps

to cover the terminal screw holes on the switching devices, neutral Poles and shunt trips for increased touch protection.

Type/ Cat No.	Std Pk
BS.UL	100

Cooling Spacer



Type/ Cat No.	Std Pk
15.960	1

Mounting Screw 34mm

to connect the auxiliary contact and shunt trip or neutral Pole to the circuit breaker.

Type/ Cat No.	Std Pk
E983419	10

Lock-out Adapter**



Type/ Cat No.	Std Pk
EASS	10

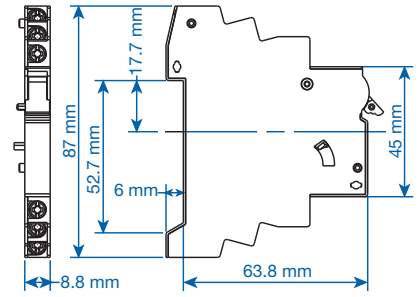

Dimensions HxxUL.

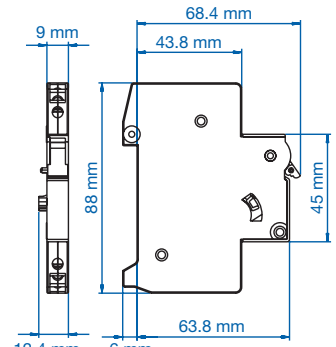

Dimensions HLS11L.

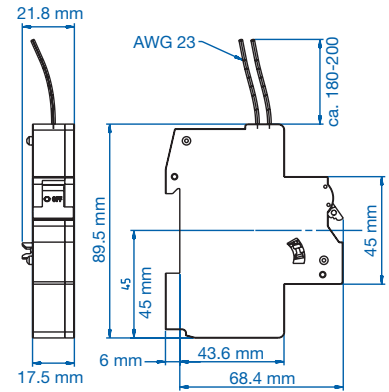

Dimensions UA120UL

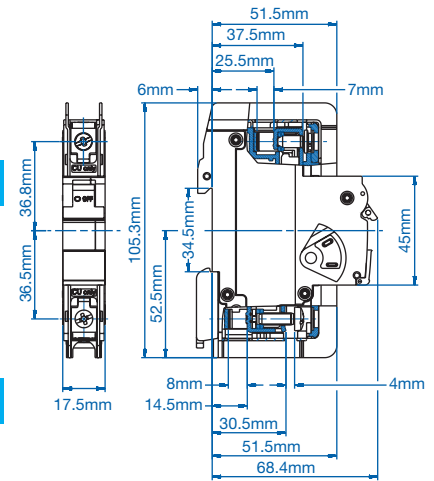

Dimensions NxxUL, FxUL

* UL not approved.

** UL and DL series can also be locked in the on and off position by simply using a common lead or meter seal, which gets fed through the hole in the handle and a corresponding hole in the housing.

UL Series (AC) Trip Curves

UL 489

UL 508

UL 1077

UL 1077
Equipment Breakers

Earth Leakage
Circuit Breakers

ANNEX

C (AC) Trip Curve

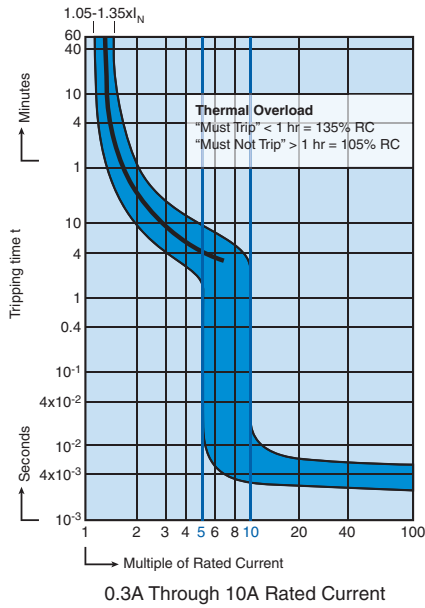

D (AC) Trip Curve

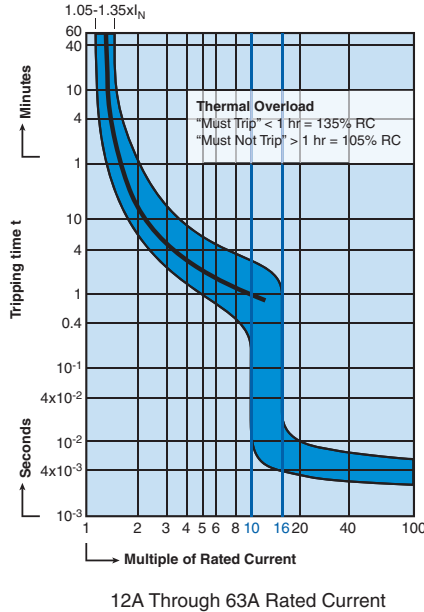
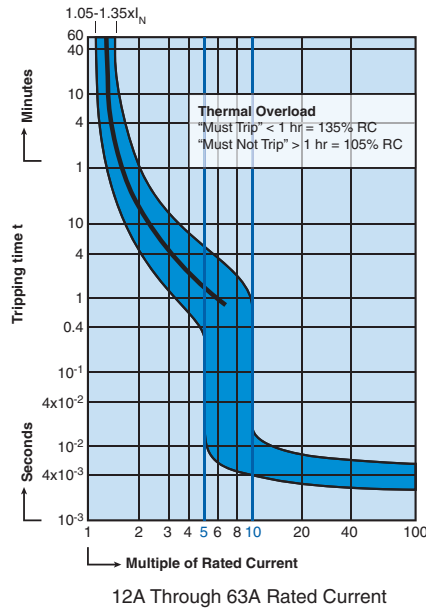
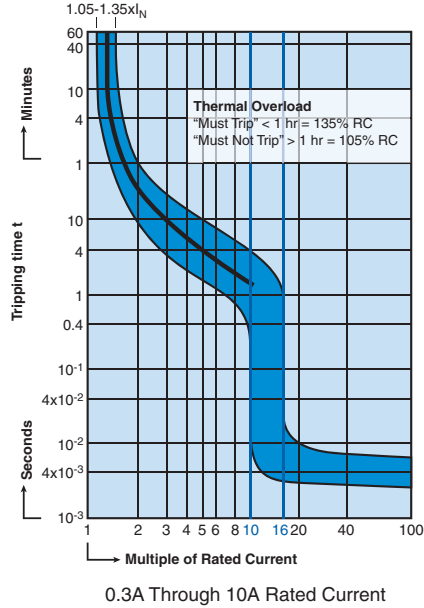

"C" Magnetic Trip Parameters Rated current 0.3A to 63A.

1. Hold for a minimum of 100ms at surge of 5 times rated current.
2. Trip in under 100ms at 10 times rated current.

"D" Magnetic Trip Parameters Rated current 0.3A to 63A.

1. Hold for a minimum of 100ms at surge of 10 times rated current.
2. Trip in under 100ms at 16 times rated current.

UL Series (DC) Trip Curves

C (DC) Trip Curve

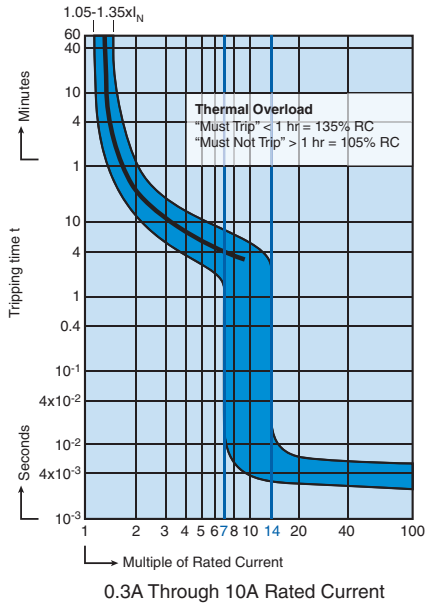

D (DC) Trip Curve

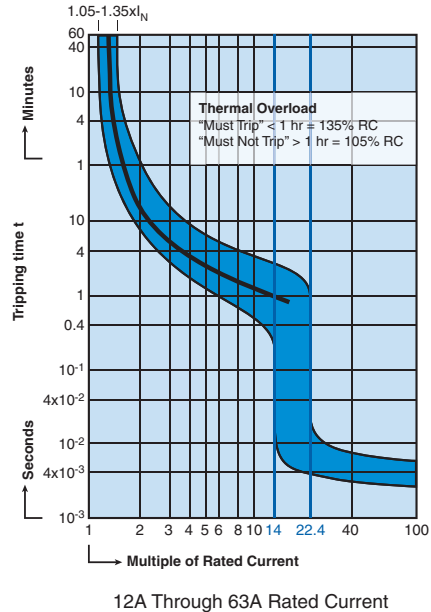
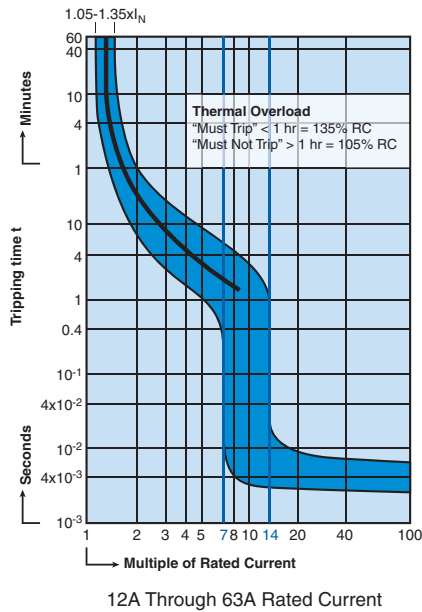
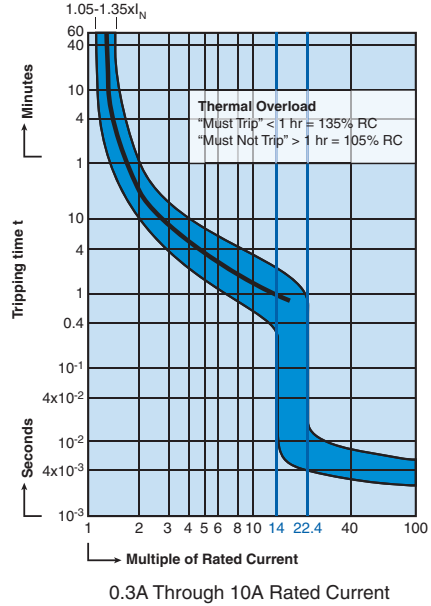

"C" Magnetic Trip Parameters

Rated current 0.3A to 63A.

1. Hold for a minimum of 100ms at surge of 7 times rated current.
2. Trip in under 100ms at 14 times rated current.

"D" Magnetic Trip Parameters

Rated current 0.3A to 63A.

1. Hold for a minimum of 100ms at surge of 14 times rated current.
2. Trip in under 100ms at 22.4 times rated current.

UL/ DL Series Internal Resistance

Rated Current (A)	Trip Characteristic	
	C (Ohm)	D (Ohm)
0.3	16.8620	16.8620
0.5	6.8540	6.0009
1.0	1.7000	1.7560
1.6	0.5870	0.5870
2.0	0.4190	0.4190
3.0	0.2020	0.2020
4.0	0.1090	0.1090
5.0	0.0654	0.0654
6.0	0.0528	0.0491
8.0	0.0278	0.0240
10	0.0216	0.0187
12	0.0084	0.0085
13	0.0084	0.0085
15/ 16	0.0085	0.0076
20	0.0067	0.0064
25	0.0050	0.0041
30/ 32	0.0032	0.0027
40	0.0025	0.0022
50	0.0019	0.0018
60/ 63	0.0018	0.0017

UL Series Let-through Energy I²t Diagram, D Trip 1 pole

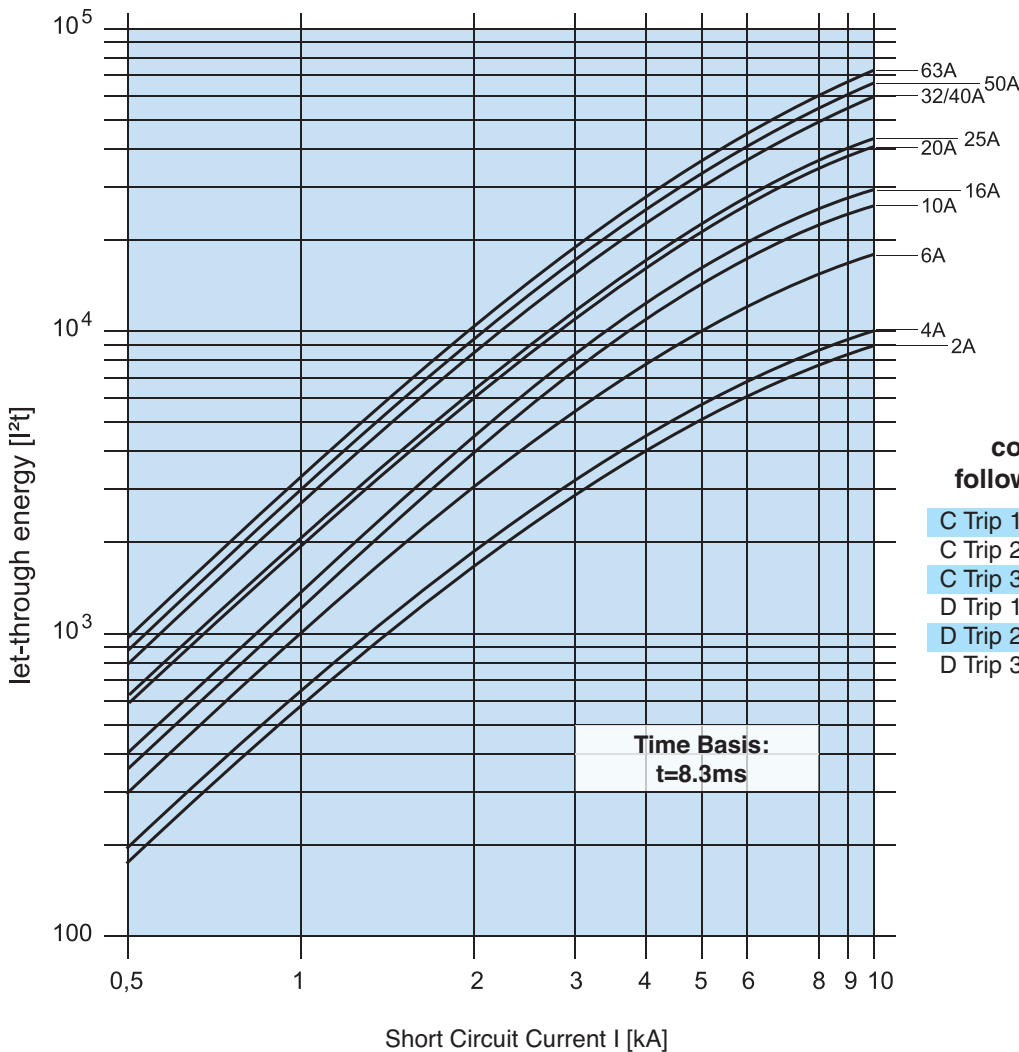

UL 489

UL 508

UL 1077

UL 1077
Equipment Breakers

Earth Leakage
Circuit Breakers

ANNEX

L-Series AC or DC

Miniature Molded Case Circuit Breakers

UL489 Listed Circuit Breakers

- Available in AC and DC models
- DIN Rail Mounted
- 17.5mm width
- Thermal Magnetic
- 240V, 480Y/277V AC, 50/60Hz
- 125VDC (1 pole); 250VDC (2 pole)
- 10kA Short Circuit Interrupting Capacity
- Positive Trip indicator (Green - off/tripped, Red - on)
- HACR Type 40°C
- Line/Load reversible

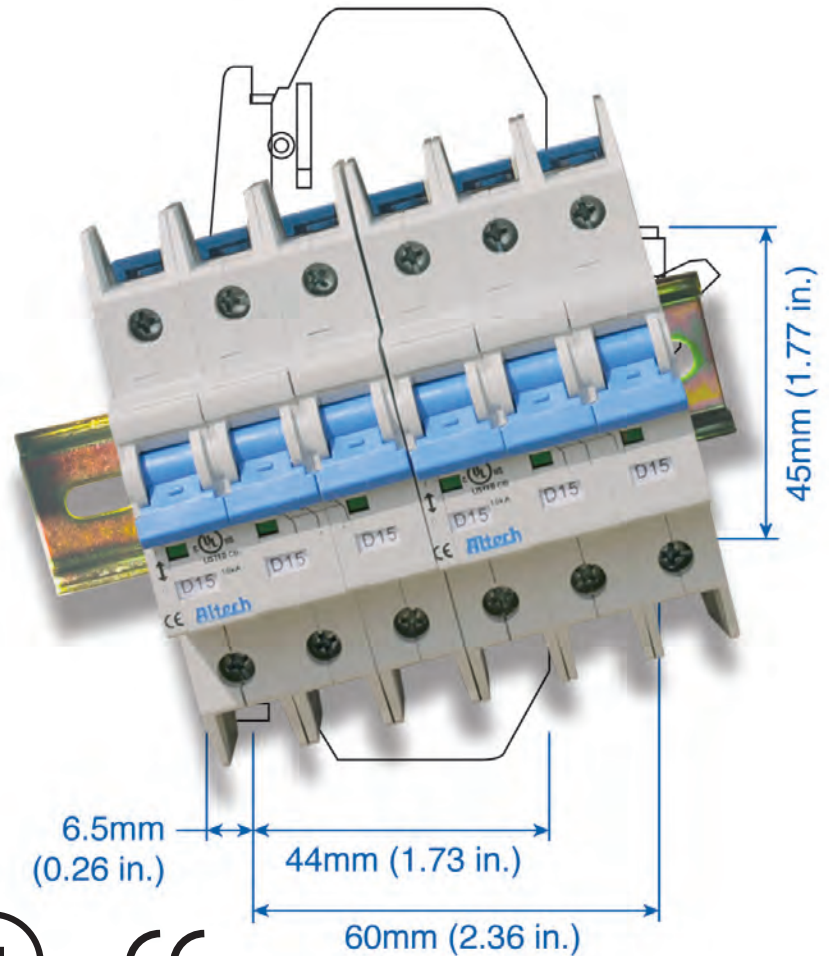

AC Version Current/ Voltage Rating	0.2-63A/240VAC, 0.2-32A/480Y/277VAC*
DC Version Current/ Voltage Rating	0.2-63A/125/250VDC
Calibration Temperature	40°C (104°F)
Operating Temperature	-25° to 60°C (-13° to 140°F)
Storage Temperature	-25° to 75°C (-13° to 167°F)
Terminal Size Acceptability and Torque	14-3 AWG: 17.5 lb-in. (2.0 Nm) 18-16 AWG: 25 lb-in. (2.8 Nm)
Terminal Protection Degree	IP20 at front
Electrical Life	6,000 cycles on/off
Mechanical Life	10,000 cycles on/off
Wire Connection	copper wire only 60/75°C
Vibration Resistance	3g (18-50Hz)
Mounting Orientation	In any plane

*One device dual voltage ratings.

AC - SHORT CIRCUIT INTERRUPTING RATING

No. Poles	Type	0.2-32A	33-63A
1	AC	10kA@120, 240, 277V	10kA@120, 240V
2-4	AC	10kA@120, 240V, 480Y/277V	10kA@120, 240V

DC - SHORT CIRCUIT INTERRUPTING RATING

No. Poles	Type	0.2-32A	33-63A
1	DC	10kA@125V	10kA@125V
2	DC	10kA@250V	10kA@250V

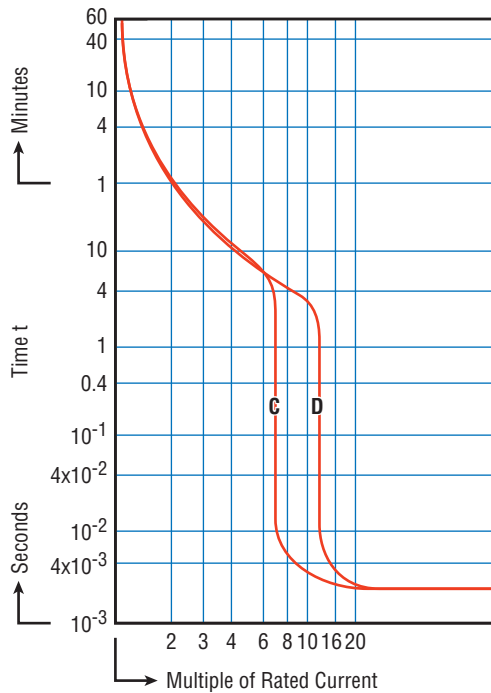

Time versus Current Trip Curve

For the exact trip curve, please refer to page 25.

Dimensions in mm side view

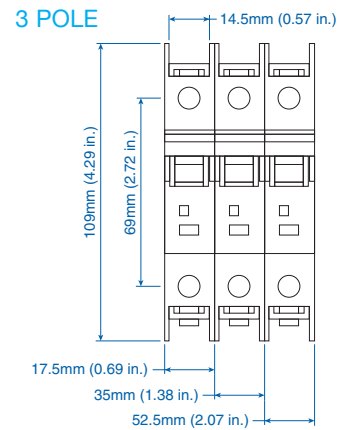
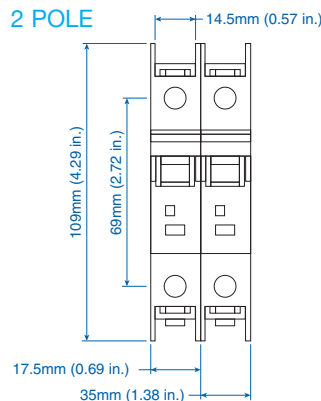
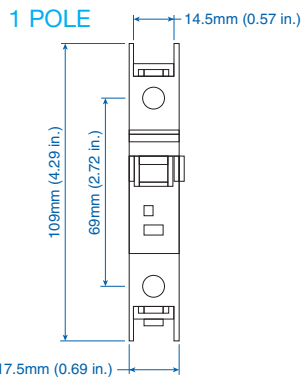
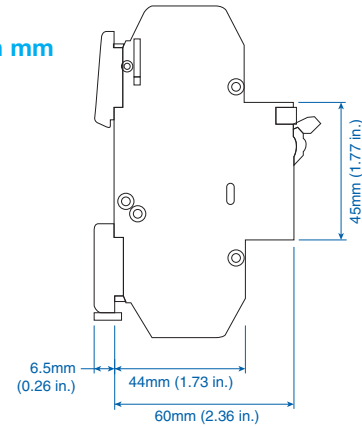

Trip-Characteristics*				Type	Applications						
Characteristic Trip Boundaries					Lighting Wiring Protection Control Circuits	Business Equipment Appliances	Transformers	Power Supplies Heaters	Motors		Reactive Load
Thermal Trip		Magnetic Trip							Low Inrush	High Inrush	
Must not Trip >100ms	Must Trip <1hr	Must not Trip >100ms	Must Trip at 100ms								
C-Characteristics											
1.05xRC	1.3xRC	5xRC	10xRC	AC							
1.05xRC	1.3xRC	5xRC	10xRC	DC							
D-Characteristics											
1.05xRC	1.3xRC	10xRC	16xRC	AC							
1.05xRC	1.3xRC	10xRC	16xRC	DC							

*The value of each characteristic is shown vertically beneath its corresponding heading.



Warning!

This information should only be used as a selection guide. The use of a Miniature Circuit Breaker in an application with a certain Trip-Characteristic always requires prototype testing! It is the responsibility of the circuit design engineer to select the appropriate Miniature Circuit Breaker for his specific application.

AC C-Trip Characteristics



LISTED
E305318

Application Examples:
Low inrush motors, resistive loads, wiring protection, receptacles, lighting, and control circuit applications. Relatively short thermal trip delay and medium magnetic trip point.



One Pole

Rated Current	Type/ Cat. No.
0.2A	1CU02L
0.5A	1CU05L
1.0A	1CU1L
1.6A	1CU1.6L
2.0A	1CU2L
3.0A	1CU3L
4.0A	1CU4L
5.0A	1CU5L
6.0A	1CU6L
8.0A	1CU8L
10A	1CU10L
12A	1CU12L
13A	1CU13L
15A	1CU15L
16A	1CU16L
20A	1CU20L
25A	1CU25L
30A	1CU30L
32A	1CU32L
40A	1CU40L
50A	1CU50L
60A	1CU60L
63A	1CU63L

Standard Pack: 12
Weight: 1.7kg (3.74 lb.)



Two Pole

Rated Current	Type/ Cat. No.
0.2A	2CU02L
0.5A	2CU05L
1.0A	2CU1L
1.6A	2CU1.6L
2.0A	2CU2L
3.0A	2CU3L
4.0A	2CU4L
5.0A	2CU5L
6.0A	2CU6L
8.0A	2CU8L
10A	2CU10L
12A	2CU12L
13A	2CU13L
15A	2CU15L
16A	2CU16L
20A	2CU20L
25A	2CU25L
30A	2CU30L
32A	2CU32L
40A	2CU40L
50A	2CU50L
60A	2CU60L
63A	2CU63L

Standard Pack: 6
Weight: 1.7kg (3.74 lb.)



Three Pole

Rated Current	Type/ Cat. No.
0.2A	3CU02L
0.5A	3CU05L
1.0A	3CU1L
1.6A	3CU1.6L
2.0A	3CU2L
3.0A	3CU3L
4.0A	3CU4L
5.0A	3CU5L
6.0A	3CU6L
8.0A	3CU8L
10A	3CU10L
12A	3CU12L
13A	3CU13L
15A	3CU15L
16A	3CU16L
20A	3CU20L
25A	3CU25L
30A	3CU30L
32A	3CU32L
40A	3CU40L
50A	3CU50L
60A	3CU60L
63A	3CU63L

Standard Pack: 4
Weight: 1.7kg (3.74 lb.)



Four Pole
Please contact
Altech.



For ring tongue terminal version, replace "U" with "R" in part number. For example **1CR20L** instead of **1CU20L**.

AC D-Trip Characteristics



Application Examples:
High inrush motors, transformers, power supplies, heaters and reactive loads.
Relatively long thermal trip delay and very high magnetic trip point.



One Pole

Rated Current	Type/ Cat. No.
0.2A	1DU02L
0.5A	1DU05L
1.0A	1DU1L
1.6A	1DU1.6L
2.0A	1DU2L
3.0A	1DU3L
4.0A	1DU4L
5.0A	1DU5L
6.0A	1DU6L
8.0A	1DU8L
10A	1DU10L
12A	1DU12L
13A	1DU13L
15A	1DU15L
16A	1DU16L
20A	1DU20L
25A	1DU25L
30A	1DU30L
32A	1DU32L
40A	1DU40L
50A	1DU50L
60A	1DU60L
63A	1DU63L

Standard Pack: 12
Weight: 1.7kg (3.74 lb.)



Two Pole

Rated Current	Type/ Cat. No.
0.2A	2DU02L
0.5A	2DU05L
1.0A	2DU1L
1.6A	2DU1.6L
2.0A	2DU2L
3.0A	2DU3L
4.0A	2DU4L
5.0A	2DU5L
6.0A	2DU6L
8.0A	2DU8L
10A	2DU10L
12A	2DU12L
13A	2DU13L
15A	2DU15L
16A	2DU16L
20A	2DU20L
25A	2DU25L
30A	2DU30L
32A	2DU32L
40A	2DU40L
50A	2DU50L
60A	2DU60L
63A	2DU63L

Standard Pack: 6
Weight: 1.7kg (3.74 lb.)



Three Pole

Rated Current	Type/ Cat. No.
0.2A	3DU02L
0.5A	3DU05L
1.0A	3DU1L
1.6A	3DU1.6L
2.0A	3DU2L
3.0A	3DU3L
4.0A	3DU4L
5.0A	3DU5L
6.0A	3DU6L
8.0A	3DU8L
10A	3DU10L
12A	3DU12L
13A	3DU13L
15A	3DU15L
16A	3DU16L
20A	3DU20L
25A	3DU25L
30A	3DU30L
32A	3DU32L
40A	3DU40L
50A	3DU50L
60A	3DU60L
63A	3DU63L

Standard Pack: 4
Weight: 1.7kg (3.74 lb.)



Four Pole
Please contact Altech.



For ring tongue terminal version, replace "U" with "R" in part number. For example **1CR20L** instead of **1CU20L**.

DC C- & D-Trip Characteristics

Application Examples:
Telecommunication equipment,
computer equipment, uninterruptable
power supplies.



LISTED
E305318



C-Trip



One Pole

Rated Current	Type/ Cat. No.
0.2A	DC1CU02L
0.5A	DC1CU05L
1.0A	DC1CU1L
1.6A	DC1CU1.6L
2.0A	DC1CU2L
3.0A	DC1CU3L
4.0A	DC1CU4L
5.0A	DC1CU5L
6.0A	DC1CU6L
8.0A	DC1CU8L
10A	DC1CU10L
12A	DC1CU12L
13A	DC1CU13L
15A	DC1CU15L
16A	DC1CU16L
20A	DC1CU20L
25A	DC1CU25L
30A	DC1CU30L
32A	DC1CU32L
40A	DC1CU40L
50A	DC1CU50L
60A	DC1CU60L
63A	DC1CU63L

Standard Pack: 12

Weight: 1.7kg (3.74 lb.)

D-Trip



One Pole

Rated Current	Type/ Cat. No.
0.2A	DC1DU02L
0.5A	DC1DU05L
1.0A	DC1DU1L
1.6A	DC1DU1.6L
2.0A	DC1DU2L
3.0A	DC1DU3L
4.0A	DC1DU4L
5.0A	DC1DU5L
6.0A	DC1DU6L
8.0A	DC1DU8L
10A	DC1DU10L
12A	DC1DU12L
13A	DC1DU13L
15A	DC1DU15L
16A	DC1DU16L
20A	DC1DU20L
25A	DC1DU25L
30A	DC1DU30L
32A	DC1DU32L
40A	DC1DU40L
50A	DC1DU50L
60A	DC1DU60L
63A	DC1DU63L

Standard Pack: 12

Weight: 1.7kg (3.74 lb.)



Two Pole

Rated Current	Type/ Cat. No.
0.2A	DC2CU02L
0.5A	DC2CU05L
1.0A	DC2CU1L
1.6A	DC2CU1.6L
2.0A	DC2CU2L
3.0A	DC2CU3L
4.0A	DC2CU4L
5.0A	DC2CU5L
6.0A	DC2CU6L
8.0A	DC2CU8L
10A	DC2CU10L
12A	DC2CU12L
13A	DC2CU13L
15A	DC2CU15L
16A	DC2CU16L
20A	DC2CU20L
25A	DC2CU25L
30A	DC2CU30L
32A	DC2CU32L
40A	DC2CU40L
50A	DC2CU50L
60A	DC2CU60L
63A	DC2CU63L

Standard Pack: 6

Weight: 1.7kg (3.74 lb.)



Two Pole

Rated Current	Type/ Cat. No.
0.2A	DC2DU02L
0.5A	DC2DU05L
1.0A	DC2DU1L
1.6A	DC2DU1.6L
2.0A	DC2DU2L
3.0A	DC2DU3L
4.0A	DC2DU4L
5.0A	DC2DU5L
6.0A	DC2DU6L
8.0A	DC2DU8L
10A	DC2DU10L
12A	DC2DU12L
13A	DC2DU13L
15A	DC2DU15L
16A	DC2DU16L
20A	DC2DU20L
25A	DC2DU25L
30A	DC2DU30L
32A	DC2DU32L
40A	DC2DU40L
50A	DC2DU50L
60A	DC2DU60L
63A	DC2DU63L

Standard Pack: 6

Weight: 1.7kg (3.74 lb.)



For ring tongue terminal version, replace "U" with "R" in part number. For example **1CR20L** instead of **1CU20L**.

L-Series Trip Curves

C and D Trip
Less than 10A

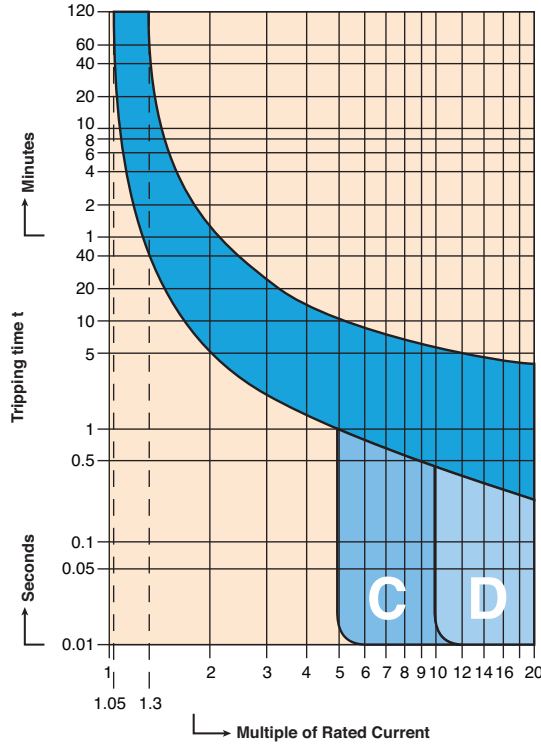

C and D Trip
10A and higher

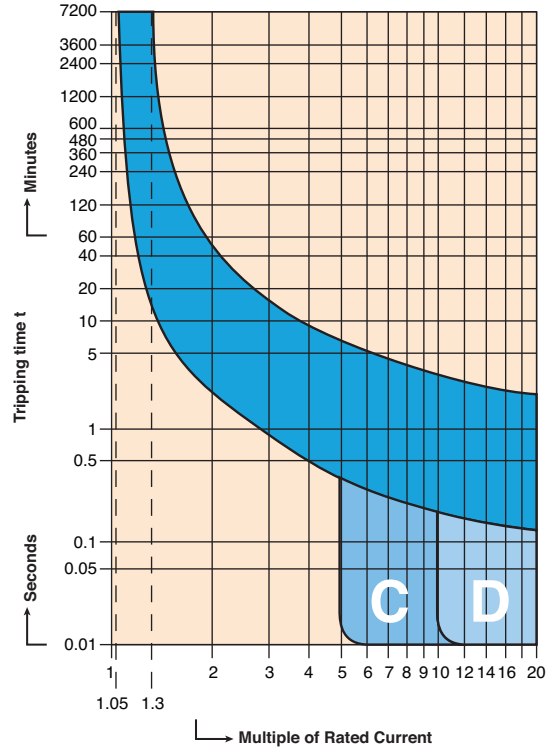

UL 489

UL 508

UL 1077

UL 1077
Equipment Breakers

Earth Leakage
Circuit Breakers

ANNEX

Temperature and Power Loss Specifications

Rated current I _n (A)	Effective rated current allowing for ambient temperature I _{cor} (A)									Internal impedance Z (mΩ) char. B, C, D, K	Power Loss B, C, D, K P (W)
	-20	-10	0	10	20	30	40	50	60		
0.2	0.24	0.24	0.23	0.22	0.21	0.2	0.19	0.18	0.17	45100.0	1.80
0.5	0.61	0.59	0.57	0.55	0.53	0.5	0.47	0.44	0.42	8000.0	2.00
1	1.21	1.18	1.14	1.1	1.05	1.0	0.93	0.88	0.83	2000.0	2.00
2	2.42	2.36	2.28	2.2	2.1	2.0	1.86	1.76	1.67	490.0	1.96
3	3.63	3.54	3.42	3.3	3.15	3.0	2.79	2.64	2.5	230.0	2.07
4	4.84	4.72	4.56	4.4	4.2	4.0	3.72	3.52	3.33	150.0	2.40
5	6.1	5.9	5.7	5.5	5.3	5.0	4.7	4.4	4.2	95.0	2.38
6	7.3	7.1	6.8	6.6	6.3	6.0	5.6	5.3	5.0	69.0	2.48
7	8.5	8.2	8.0	7.7	7.4	7.0	6.5	6.2	5.8	52.0	2.55
8	9.7	9.4	9.1	8.8	8.4	8.0	7.4	7.0	6.7	35.0	2.24
10	12.1	11.8	11.4	11.0	10.5	10.0	9.3	8.8	8.3	23.5	2.35
12	14.5	14.2	13.7	13.2	12.6	12.0	11.2	10.6	10.0	18.7	2.69
13	15.7	15.3	14.8	14.3	13.7	13.0	12.1	11.5	10.8	14.3	2.42
14	16.9	16.5	16.0	15.4	14.7	14.0	13.0	12.3	11.7	12.4	2.43
15	18.2	17.7	17.1	16.5	15.8	15.0	14.0	13.2	12.5	10.1	2.27
16	19.4	18.9	18.2	17.6	16.8	16.0	14.9	14.1	13.3	7.5	1.92
20	24.2	23.6	22.8	22.0	21.0	20.0	18.6	17.6	16.7	6.3	2.52
25	30.3	29.5	28.5	27.5	26.3	25.0	23.3	22.0	20.8	4.6	2.88
30	36.3	35.4	34.2	33.0	31.5	30.0	27.9	26.5	25.0	3.6	3.24
32	38.7	37.8	36.5	35.2	33.6	32.0	29.8	28.2	26.7	3.6	3.69
35	42.3	41.3	39.9	38.5	36.8	35.0	32.6	30.8	29.2	3.6	4.41
40	48.4	47.2	45.6	44.0	42.0	40.0	37.2	35.2	33.3	3.0	4.80
50	60.5	59.0	57.0	55.0	52.5	50.0	46.5	44.1	41.7	2.4	6.00
60	72.6	70.9	68.4	66.0	63.0	60.0	55.9	52.9	50.1	1.8	6.48

Accessories

L-Series Circuit Breakers



Accessories can be factory or field mounted on L-Series miniature molded case circuit breakers for enhanced control and monitoring capabilities. Field mounting kits include all necessary parts and instructions. Accessories can be gang mounted on a single controller (the Auxiliary Switch in the outside position). The mounting arrangement links the internal latch-pins for the tripping mechanisms, ensuring simultaneous trips. Handles are linked to simplify manual resetting.



Neutral Pole

(63A/240VAC; 32A/480Y/277VAC)

Description	Type/ Cat. No.	Cable Max	Cable Min	Torque Max	Torque Min
Neutral	ALTN2L	25mm ² 3 AWG	2.5mm ² 12 AWG	2Nm 17.5 lb-in	1.5Nm 12 lb-in

Standard Pack: 10

Weight: 1.2kg (2.64 lb.)

Shunt Trip and Undervoltage Trip

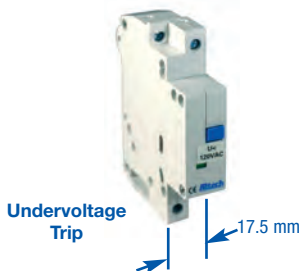

Description	Shunt Trip Type/Cat. No.	Operational Voltage	Rated Coil Current	Undervoltage Trip* Type/Cat. No.
AC Coil:				
12V AC	FA12ACL	8.4 - 13.2V	6A	UV12ACL
24V AC	FA24ACL	16.8 - 26.4V	2.8A	UV24ACL
48V AC	FA48ACL	33.6 - 52.8V	0.8A	UV48ACL
60V AC	FA60ACL	42 - 66V	~0.7A	UV60ACL
110V AC	FA110ACL	77 - 121V	0.5A	UV110ACL
120V AC	FA120ACL	84 - 132V	~0.5A	UV120ACL
230V AC	FA230ACL	161 - 253V	0.6A	UV230ACL
277V AC	FA277ACL	194 - 305V	~0.5A	UV277ACL
400V AC	FA400ACL	280 - 440V	0.5A	UV400ACL
DC Coil:				
12V DC	FA12DCL	8.4 - 13.2V	~6A	UV12DCL
24V DC	FA24DCL	16.8 - 26.4V	3A	UV24DCL
48V DC	FA48DCL	33.6 - 52.8V	2A	UV48DCL
110V DC	FA110DCL	77 - 121V	0.6A	UV110DCL

* Reset-Hold Voltage = 0.85 x V_E; Drop-Out Voltage = 0.2 x V_E

Standard Pack: 10

Weight: 1.1kg (2.43 lb.)

Terminal Size - min/max	2.5 mm ² (12 AWG) / 25mm ² (3 AWG)
Terminal Torque - min/max	1.5 Nm (12 lb. in.) / 2 Nm (17.5 lb. in.)

Accessories

L-Series Circuit Breakers



LISTED
E305318

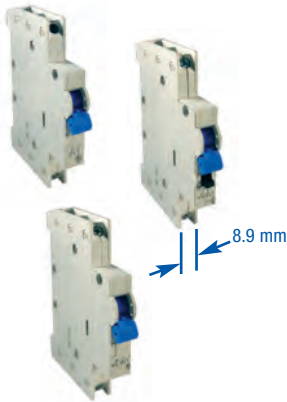

Auxiliary Contact

(6A/120V AC; 3A/240V AC; 6A/24V DC; 0.5A/125V DC)

Description	Type/ Cat. No.	Cable Max	Cable Min	Torque Max	Torque Min
1 x CO	H1COL				
2 x CO	H2COL	2.5mm ² 12 AWG	0.5mm ² 20 AWG	0.5Nm 4 lb-in	0.33Nm 3 lb-in
1 x CO, 1 Signal & Test Button	HSTCOL				

Standard Pack: 15

Weight: 0.5kg (1.32 lb.)

Wiring Diagram

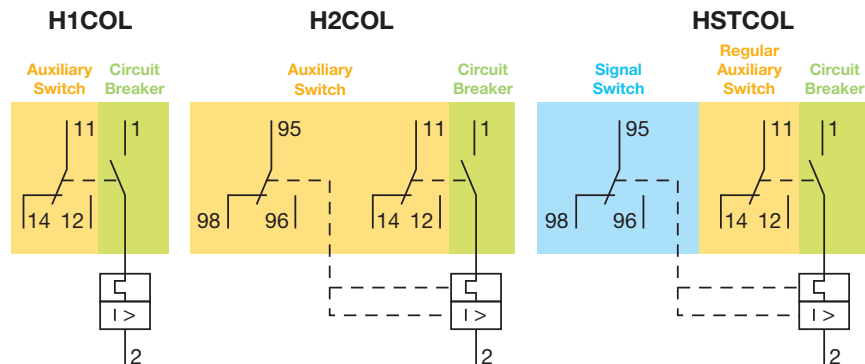

Lock-out Adapter



Description	Type/ Cat. No.
Yellow	EASS2L

Standard Pack: 10

Weight: 50g (1.76 oz.)



Front Mounting Kit with hardware

Description	Type/ Cat. No.	Weight
1 Pole	FMA1PL	40g (1.41 oz.)
2 Pole	FMA2PL	45g (1.59 oz.)
3 Pole	FMA3PL	50g (1.76 oz.)

Standard Pack: 1

UL 489

UL 508

UL 1077

UL 1077
Equipment Breakers

Earth Leakage
Circuit Breakers

ANNEX

Altech UL489 Busbar System



UL489 recognized
E305318

UL489 Listed Busbars

The Altech Busbar System is an innovative way to jumper up to 57 poles of Miniature Molded Case Circuit Breakers.

The advantages of this busbar system are:

- 30% Installation time savings
- Panel space savings
- Reduced maintenance
- High electrical ratings

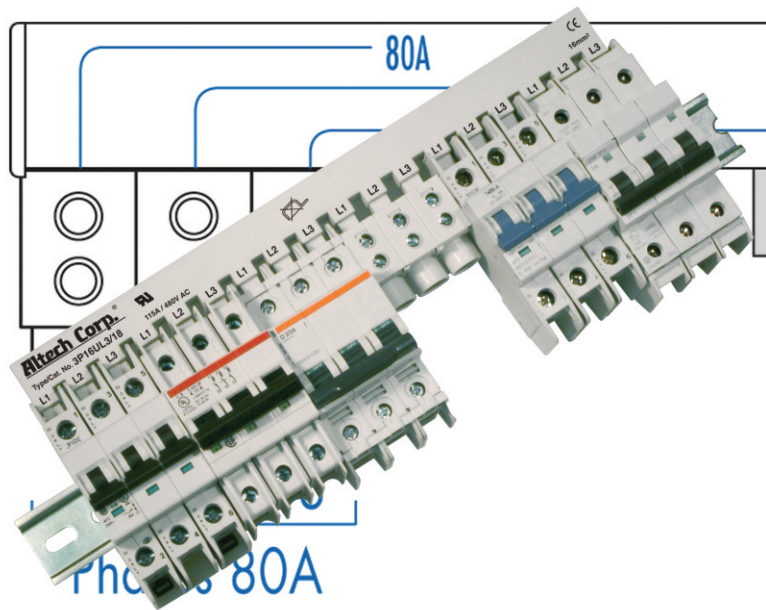

**Universal UL489 Busbar
fits most UL489 Miniature
Circuit Breakers in the market!**

Please contact Altech for details and further information.

UL489 Busbar System

- Every pin configuration is possible by combination of existing 6, 12 and 18 pin busbars.
- Power Feeding:
Power Feed Lug (115A), Direct Power Feed (115A)
- UL listed for Altech's L-Series and ABL's UL-Series of Miniature Circuit Breakers
- UL listed for use with most popular UL489 Miniature Circuit Breakers in the market.

Technical Specifications

Material of Busbar

Busbars UL489

Copper

Material of Insulation (Housing)

Polyamide

Electrical Ratings

115A/600V AC/DC

Short Circuit Withstand Rating

10kA

Applying Standards

UL489, VDE0660 Part 100,
IEC60749, DIN EN60947-1

Altech UL489 Busbar System

Power Feed Methods

End Feed Method

P35ULT

With the **P35ULT** Power Feed Lug as a Start/End Feeding Device a maximum input current of **115A per Phase** can be achieved.

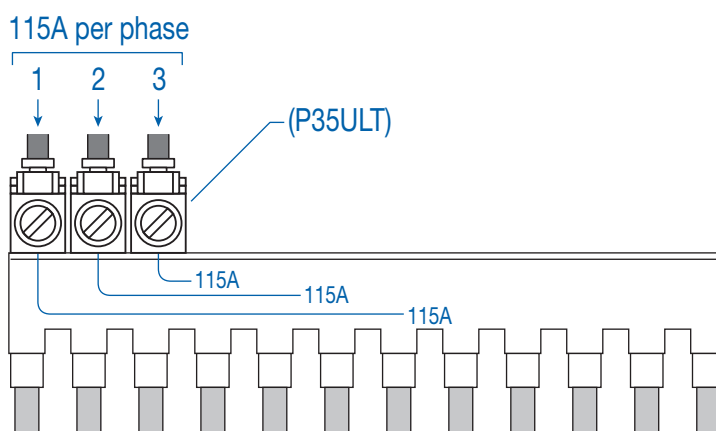

P50ULB

With the **P50ULB** Modular Direct Power Feed as a Start/End Feeding Device a maximum input current of **115A per Phase** can be achieved.

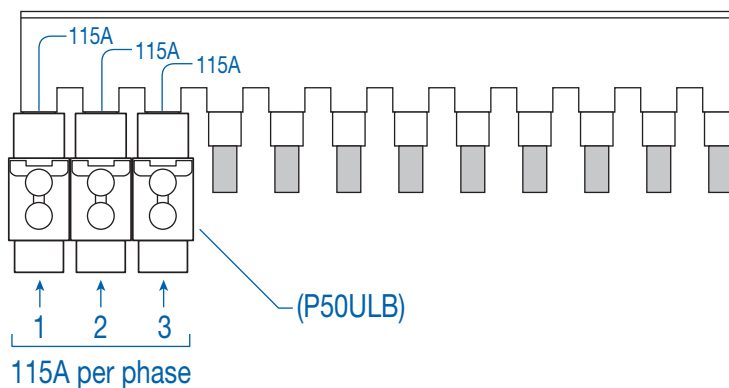

* For complete specifications and description of Feeding Devices see page 33.

1 PHASE BUSBAR 16mm² for 115A

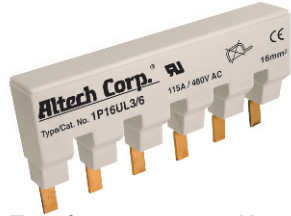

UL489 recognized E305318

Type/
Cat. No. No. of Pins Length [mm]

1P16UL3/6 6 99

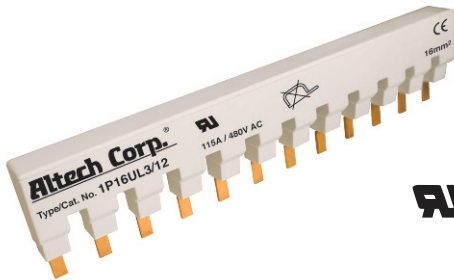
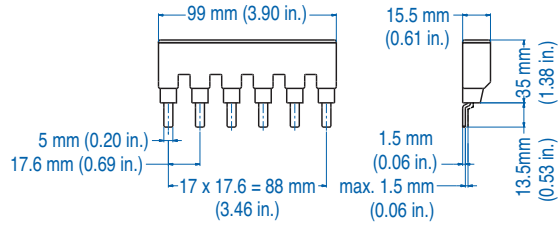

UL489 recognized E305318

Type/
Cat. No. No. of Pins Length [mm]

1P16UL3/12 12 204.6

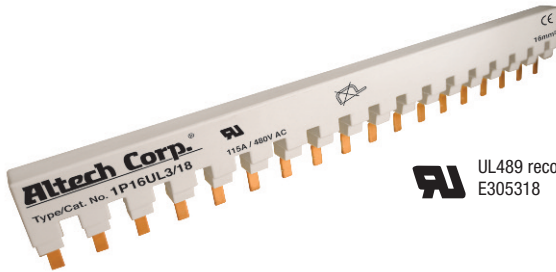
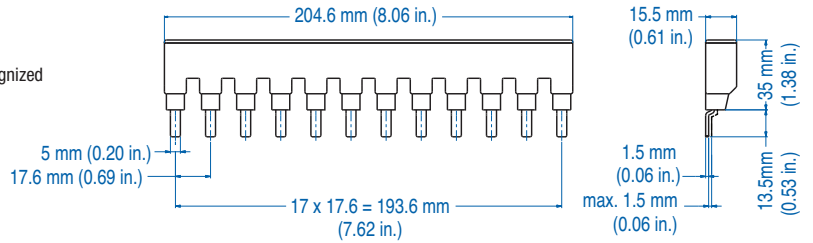

UL489 recognized E305318

Type/
Cat. No. No. of Pins Length [mm]

1P16UL3/18 18 310.2

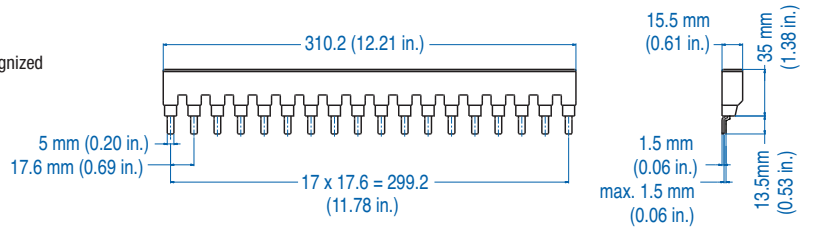

Example for different No. of Pins

eg. 44 pins use 1x 1P16UL3/12 + 2x 1P16UL3/18

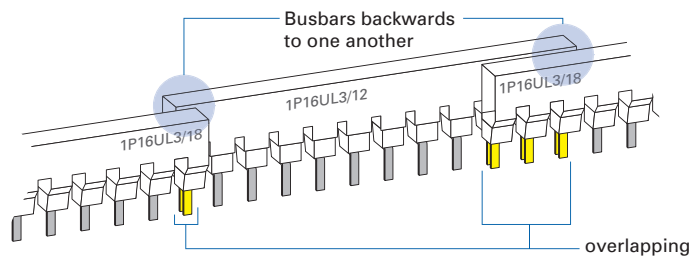

- No. of overlapping pins of 2 busbars must be a multiplier of the No. of phases
- Overlapping busbars are backwards to each other

ACCESSORIES



Type/Cat. No.: **P35ULT**
Description: Power Feed Lug

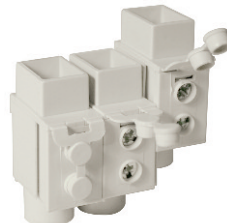

Type/Cat. No.: **P50ULB**
Description: Modular Direct Power Feed



Type/Cat. No.: **BRUL (3 per strip)**
Description: Insulation Cap

2 PHASE BUSBAR 16mm² for 115A

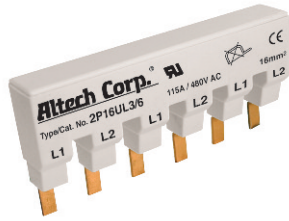

UL489 recognized
E305318

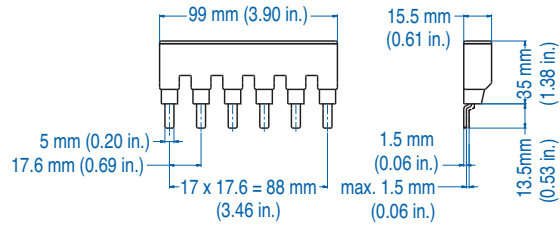

Type/ Cat. No. **No. of Pins** **Length [mm]**

2P16UL3/6 6 99

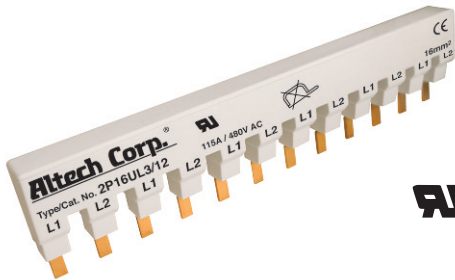

UL489 recognized
E305318

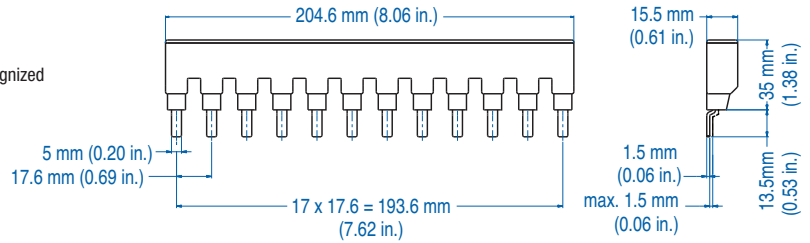

Type/ Cat. No. **No. of Pins** **Length [mm]**

2P16UL3/12 12 204.6

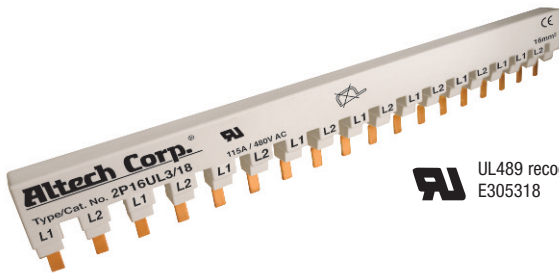

UL489 recognized
E305318

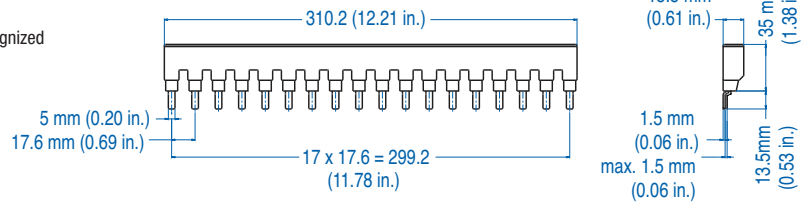

Type/ Cat. No. **No. of Pins** **Length [mm]**

2P16UL3/18 18 310.2

Example for different No. of Pins
eg. 30 pins use 3x 2P16UL3/12

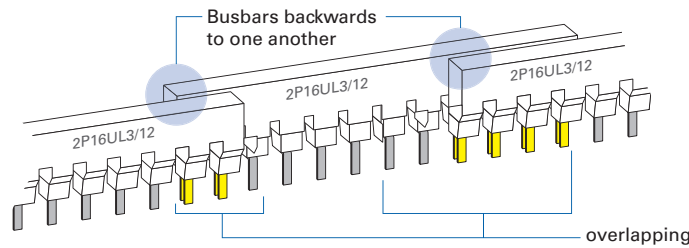

- No. of overlapping pins of 2 busbars must be multiplier of the No. of phases
- Overlapping busbars are backwards to each other

ACCESSORIES



Type/Cat. No.: **P35ULT**
Description: Power Feed Lug

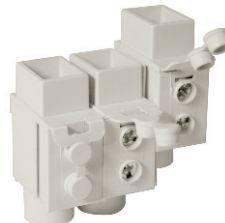

Type/Cat. No.: **P50ULB**
Description: Modular Direct Power Feed



Type/Cat. No.: **BRUL (3 per strip)**
Description: Insulation Cap

UL 489

UL 508

UL 1077

UL 1077
Equipment Breakers

Earth Leakage
Circuit Breakers

ANNEX

3 PHASE BUSBAR 16mm² for 115A

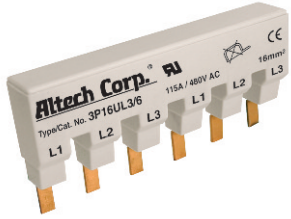

UL UL489 listed
E305318

Type/ Cat. No.	No. of Pins	Length [mm]
3P16UL3/6	6	99

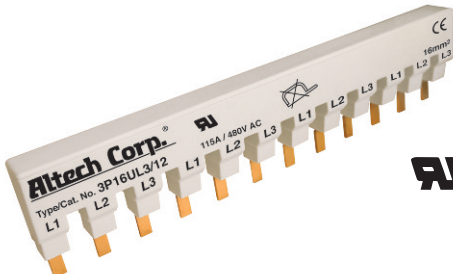
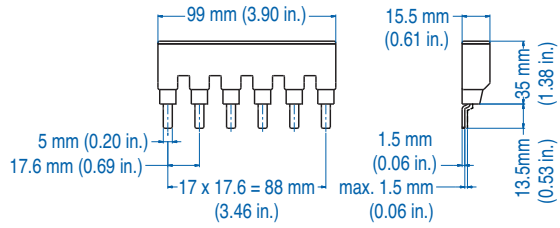

UL UL489 listed
E305318

Type/ Cat. No.	No. of Pins	Length [mm]
3P16UL3/12	12	204.6

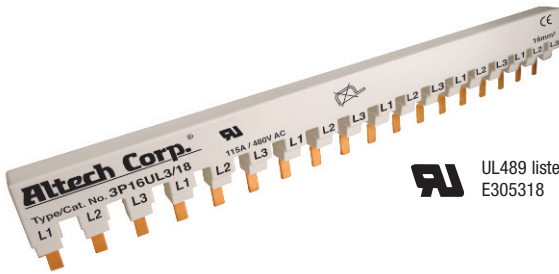
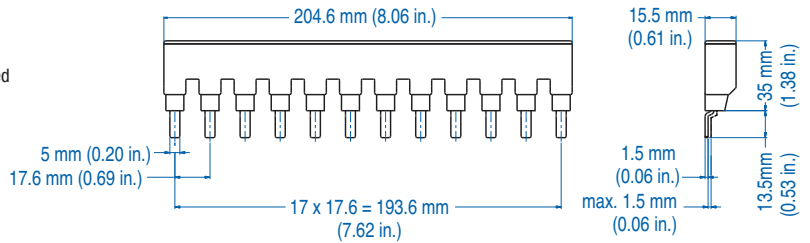

UL UL489 listed
E305318

Type/ Cat. No.	No. of Pins	Length [mm]
3P16UL3/18	18	310.2

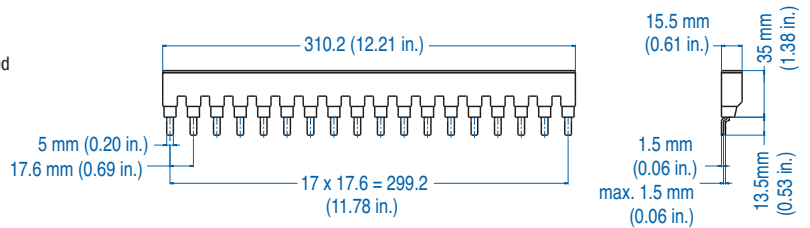

Example for different No. of Pins

eg. 39 pins use 1x 3P16UL3/12 + 2x 3P16UL3/18

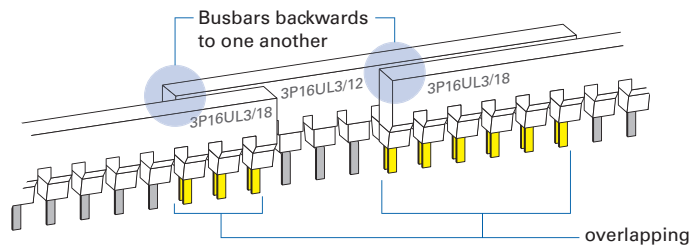

- No. of overlapping pins of 2 busbars must be multiplier of the No. of phases
- Overlapping busbars are backwards to each other

ACCESSORIES



Type/Cat. No: **P35ULT**
Description: Power Feed Lug



Type/Cat. No: **P50ULB**
Description: Modular Direct Power Feed



Type/Cat. No: **BRUL (3 per strip)**
Description: Insulation Cap

Power Feed Devices

Easy connection of power supply wires to the busbar/MCB. Power Feed Devices ensure permanent connection.

Power Feed Lug



UL UL489 listed
E305318

Modular Direct Power Feed

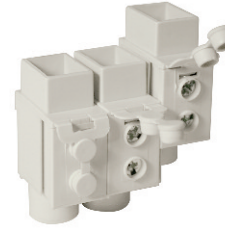

UL UL489 listed
E305318



Type/Cat. No.	P35ULT	P50ULB
Electrical Ratings	115A/600V AC/DC	115A/600V AC/DC
Wire Range	14-2 AWG Cu	14-1 AWG Cu
Wire Temperature Rating	75°C	75°C
Required Torque	4Nm (35.4 lb. in.)	Cable 3.5Nm/31 lb. in. (14-6AWG) Side 4Nm/35.4 lb. in. (4-1AWG) Busbar Side 2.5Nm/22 lb. in.
Material of Lug	Brass	Brass
Insulation Material	Polyamide	Polyamide
For use with	UL489 1, 2, 3 phase Busbar	UL489 1, 2, 3 phase Busbar

Dimensions

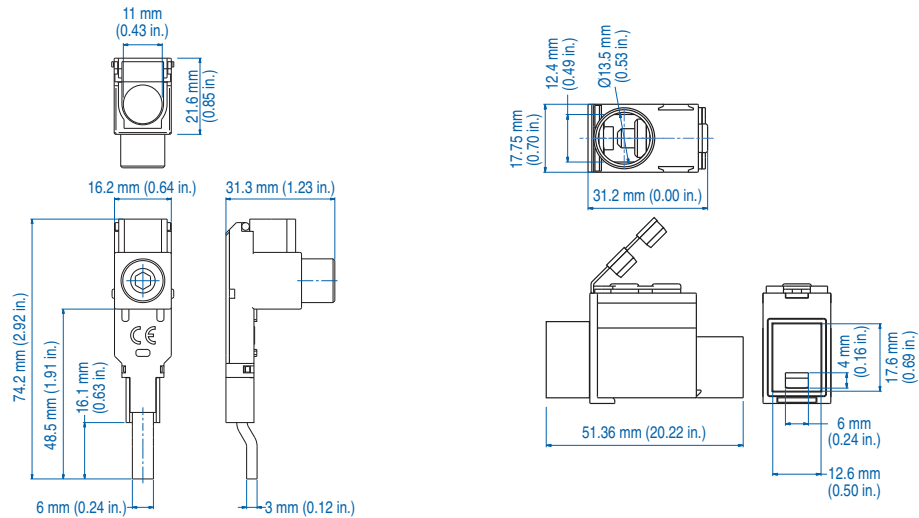

Assembly Instructions

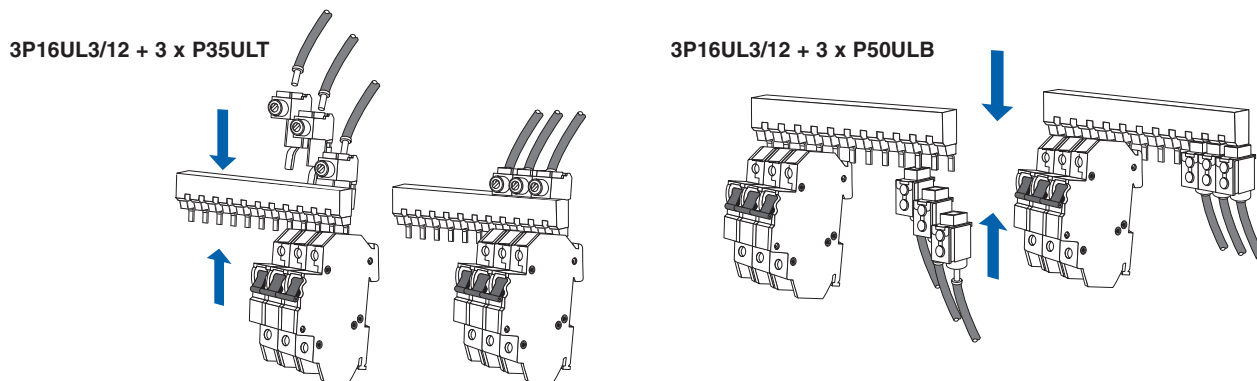

Accessories

Insulation Caps



Type/Cat. No: **BRUL** (3 per strip)
Description: Insulation Cap

UL 489

UL 508

UL 1077

UL 1077
Equipment Breakers

Earth Leakage
Circuit Breakers

ANNEX

Altech UL489 Busbar Systems

Configuration and Assembly of UL489 Busbars

UL489 Busbars are available in 3 different Pin Configurations per Phase, (6, 12 and 18 Pins).

The UL489 busbar cannot be cut, since the creepage and clearance distance requirements from UL are too stringent. Therefore, to obtain the desired No. of Pins, Busbar-Pins can be overlapped as explained below:

- 1) Busbars are overlapped backwards to each other. Both Pins of each Busbar fit together in the terminals of the Miniature Circuit Breaker.
- 2) The Number of overlapping Pins of 2 Busbar must be a multiplier of the Number of Phases to keep existing Phase sequence. (Can be overlapped by more than the number of phases).
- 3) Any available combination of the 3 different Pin configurations is possible.
- 4) In most cases there is more than 1 combination possible.
- 5) For more possible configurations see Busbar Selection Table on page 21.

Configuration Examples*

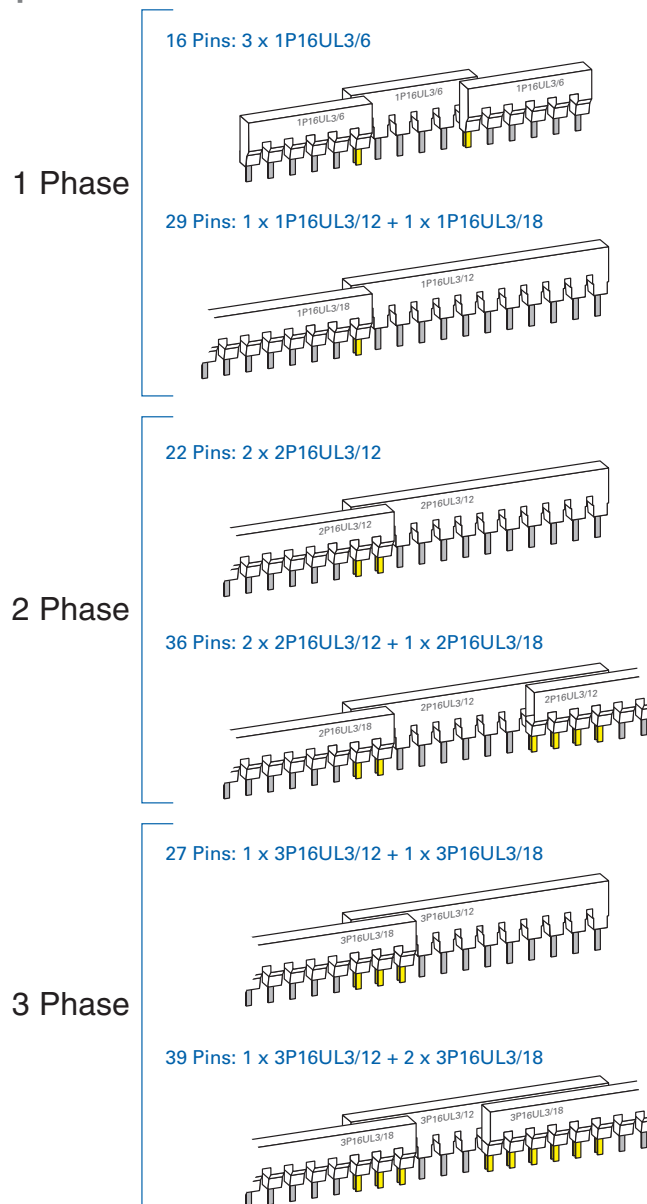

*For Questions, other configurations and detailed information please contact Altech Corp.

Busbar Selection Table

UL 489

UL 508

UL 1077

UL 1077
Equipment Breakers

Earth Leakage
Circuit Breakers

ANNEX

No. of Pins	Necessary Busbars	No. of Pins	Necessary Busbars	No. of Pins	Necessary Busbars	No. of Pins	Necessary Busbars
1 Phase System							
6	1x 1P16UL3/6	27	2x 1P16UL3/18 1x 1P16UL3/12 + 1x 1P16UL3/18	43	1x 1P16UL3/12 + 2x 1P16UL3/18 3x 1P16UL3/18	38	1x 2P16UL3/6 + 2x 2P16UL3/18 3x 2P16UL3/18
7	2x 1P16UL3/6		2x 1P16UL3/6 + 1x 1P16UL3/18 3x 1P16UL3/12	44	1x 1P16UL3/12 + 2x 1P16UL3/18 3x 1P16UL3/18		2x 2P16UL3/12 + 1x 2P16UL3/18 1x 2P16UL3/12 + 2x 2P16UL3/18
8	2x 1P16UL3/6	28	2x 1P16UL3/18 1x 1P16UL3/12 + 1x 1P16UL3/18	45	1x 1P16UL3/12 + 2x 1P16UL3/18 3x 1P16UL3/18	40	3x 2P16UL3/18 1x 2P16UL3/12 + 2x 2P16UL3/18
9	2x 1P16UL3/6		2x 1P16UL3/6 + 1x 1P16UL3/18 3x 1P16UL3/12	46	1x 1P16UL3/12 + 2x 1P16UL3/18 3x 1P16UL3/18	42	3x 2P16UL3/18 1x 2P16UL3/12 + 2x 2P16UL3/18
10	2x 1P16UL3/6	29	2x 1P16UL3/18 1x 1P16UL3/12 + 1x 1P16UL3/18	47	3x 1P16UL3/18	44	3x 2P16UL3/18 1x 2P16UL3/12 + 2x 2P16UL3/18
11	2x 1P16UL3/6		1x 1P16UL3/6 + 1x 1P16UL3/12 1x 1P16UL3/6 + 2x 1P16UL3/12	48	3x 1P16UL3/18	46	3x 2P16UL3/18
12	1x 1P16UL3/12 3x 1P16UL3/6	30	2x 1P16UL3/18 3x 1P16UL3/12 1x 1P16UL3/6 + 1x 1P16UL3/12 + 1x 1P16UL3/18	50	3x 1P16UL3/18	48	3x 2P16UL3/18
13	2x 1P16UL3/12 3x 1P16UL3/6 1x 1P16UL3/6 + 1x 1P16UL3/12		2x 1P16UL3/12 + 1x 1P16UL3/18 1x 1P16UL3/12 + 2x 1P16UL3/18	51	3x 1P16UL3/18	50	3x 2P16UL3/18
14	2x 1P16UL3/12 3x 1P16UL3/6 1x 1P16UL3/6 + 1x 1P16UL3/12	31	2x 1P16UL3/18 3x 1P16UL3/12 1x 1P16UL3/6 + 1x 1P16UL3/12 + 1x 1P16UL3/18	2 Phase System			
15	2x 1P16UL3/12 3x 1P16UL3/6 1x 1P16UL3/6 + 1x 1P16UL3/12		2x 1P16UL3/12 + 1x 1P16UL3/18 1x 1P16UL3/12 + 2x 1P16UL3/18	6	1x 2P16UL3/6	9	2x 3P16UL3/6
16	2x 1P16UL3/12 3x 1P16UL3/6 1x 1P16UL3/6 + 1x 1P16UL3/12	32	2x 1P16UL3/18 3x 1P16UL3/12 1x 1P16UL3/6 + 1x 1P16UL3/12 + 1x 1P16UL3/18	8	2x 2P16UL3/6	12	1x 3P16UL3/12 3x 3P16UL3/6
17	2x 1P16UL3/12 1x 1P16UL3/6 + 1x 1P16UL3/12		2x 1P16UL3/12 + 1x 1P16UL3/18 1x 1P16UL3/12 + 2x 1P16UL3/18	10	2x 2P16UL3/6	15	1x 3P16UL3/6 + 1x 3P16UL3/12 2x 3P16UL3/12
18	1x 1P16UL3/18 2x 1P16UL3/12 2x 1P16UL3/6 + 1x 1P16UL3/12 1x 1P16UL3/6 + 2x 1P16UL3/12	33	2x 1P16UL3/18 3x 1P16UL3/12 1x 1P16UL3/6 + 1x 1P16UL3/12 + 1x 1P16UL3/18	12	3x 2P16UL3/6 1x 2P16UL3/12	18	1x 3P16UL3/18 1x 3P16UL3/12 + 2x 3P16UL3/6 2x 3P16UL3/12
19	2x 1P16UL3/12 2x 1P16UL3/18 2x 1P16UL3/6 + 1x 1P16UL3/12 1x 1P16UL3/6 + 2x 1P16UL3/12 1x 1P16UL3/6 + 1x 1P16UL3/18 1x 1P16UL3/12 + 1x 1P16UL3/18		2x 1P16UL3/12 + 1x 1P16UL3/18 1x 1P16UL3/12 + 2x 1P16UL3/18	14	3x 2P16UL3/6 2x 2P16UL3/12 1x 2P16UL3/6 + 1x 2P16UL3/12	21	2x 3P16UL3/12 1x 3P16UL3/6 + 1x 3P16UL3/18 1x 3P16UL3/12 + 1x 3P16UL3/18 2x 3P16UL3/18
20	2x 1P16UL3/12 2x 1P16UL3/18 1x 1P16UL3/6 + 2x 1P16UL3/12 2x 1P16UL3/6 + 1x 1P16UL3/12 1x 1P16UL3/6 + 1x 1P16UL3/18 1x 1P16UL3/12 + 1x 1P16UL3/18	34	2x 1P16UL3/18 3x 1P16UL3/12 1x 1P16UL3/6 + 1x 1P16UL3/12 + 1x 1P16UL3/18	16	2x 2P16UL3/12 1x 2P16UL3/6 + 1x 2P16UL3/12	24	1x 3P16UL3/12 + 1x 3P16UL3/18 2x 3P16UL3/6 + 1x 3P16UL3/18 1x 3P16UL3/6 + 2x 3P16UL3/12 3x 3P16UL3/12 2x 3P16UL3/18
21	2x 1P16UL3/12 2x 1P16UL3/18 2x 1P16UL3/6 + 1x 1P16UL3/12 1x 1P16UL3/6 + 2x 1P16UL3/12 1x 1P16UL3/6 + 1x 1P16UL3/18 1x 1P16UL3/12 + 1x 1P16UL3/18	35	2x 1P16UL3/18 1x 1P16UL3/12 + 1x 1P16UL3/18 1x 1P16UL3/12 + 2x 1P16UL3/18	18	1x 2P16UL3/18 2x 2P16UL3/12 2x 2P16UL3/6 + 1x 2P16UL3/12	27	1x 3P16UL3/12 + 1x 3P16UL3/18 2x 3P16UL3/18 3x 3P16UL3/12
22	2x 1P16UL3/12 2x 1P16UL3/18 2x 1P16UL3/6 + 1x 1P16UL3/12 1x 1P16UL3/6 + 2x 1P16UL3/12 1x 1P16UL3/6 + 1x 1P16UL3/18 1x 1P16UL3/12 + 1x 1P16UL3/18		2x 1P16UL3/12 + 1x 1P16UL3/18 1x 1P16UL3/12 + 2x 1P16UL3/18	20	2x 2P16UL3/6 + 1x 2P16UL3/12 1x 2P16UL3/6 + 1x 2P16UL3/18 2x 2P16UL3/12 2x 2P16UL3/18 1x 2P16UL3/12 + 1x 2P16UL3/18	30	2x 3P16UL3/18 2x 3P16UL3/12 + 1x 3P16UL3/18 1x 3P16UL3/6 + 1x 3P16UL3/12 + 1x 3P16UL3/18
23	2x 1P16UL3/12 2x 1P16UL3/18 1x 1P16UL3/6 + 1x 1P16UL3/18 1x 1P16UL3/12 + 1x 1P16UL3/18	36	1x 1P16UL3/6 + 2x 1P16UL3/18 2x 1P16UL3/12 + 1x 1P16UL3/18 3x 1P16UL3/18 1x 1P16UL3/12 + 2x 1P16UL3/18	22	2x 2P16UL3/12 2x 2P16UL3/18 1x 2P16UL3/6 + 1x 2P16UL3/18 1x 2P16UL3/12 + 1x 2P16UL3/18	33	2x 3P16UL3/18 2x 3P16UL3/12 + 1x 3P16UL3/18
24	2x 1P16UL3/12 2x 1P16UL3/18 1x 1P16UL3/12 + 1x 1P16UL3/18 2x 1P16UL3/6 + 1x 1P16UL3/18 3x 1P16UL3/12	37	1x 1P16UL3/6 + 2x 1P16UL3/18 2x 1P16UL3/12 + 1x 1P16UL3/18 3x 1P16UL3/18 1x 1P16UL3/12 + 2x 1P16UL3/18	26	2x 2P16UL3/6 + 1x 2P16UL3/18 1x 2P16UL3/6 + 2x 2P16UL3/12 3x 2P16UL3/12 2x 2P16UL3/18 1x 2P16UL3/12 + 1x 2P16UL3/18	36	1x 3P16UL3/6 + 2x 3P16UL3/18 2x 3P16UL3/12 + 1x 3P16UL3/18 1x 3P16UL3/12 + 2x 3P16UL3/18 3x 3P16UL3/18
25	2x 1P16UL3/12 2x 1P16UL3/18 1x 1P16UL3/12 + 1x 1P16UL3/18 2x 1P16UL3/6 + 1x 1P16UL3/18 3x 1P16UL3/12		1x 1P16UL3/6 + 2x 1P16UL3/18 2x 1P16UL3/12 + 1x 1P16UL3/18	28	3x 2P16UL3/12 2x 2P16UL3/18 1x 2P16UL3/12 + 1x 2P16UL3/18	39	1x 3P16UL3/12 + 2x 3P16UL3/18 3x 3P16UL3/18
26	2x 1P16UL3/18 1x 1P16UL3/12 + 1x 1P16UL3/18 2x 1P16UL3/6 + 1x 1P16UL3/18 3x 1P16UL3/12	38	1x 1P16UL3/6 + 2x 1P16UL3/18 2x 1P16UL3/12 + 1x 1P16UL3/18 3x 1P16UL3/18 1x 1P16UL3/12 + 2x 1P16UL3/18	30	1x 2P16UL3/6 + 1x 2P16UL3/12 + 1x 2P16UL3/18 3x 2P16UL3/12 2x 2P16UL3/12 + 1x 2P16UL3/18 2x 2P16UL3/18	42	1x 3P16UL3/12 + 2x 3P16UL3/18 3x 3P16UL3/18
		39	1x 1P16UL3/6 + 2x 1P16UL3/18 2x 1P16UL3/12 + 1x 1P16UL3/18 3x 1P16UL3/18 1x 1P16UL3/12 + 2x 1P16UL3/18	32	1x 2P16UL3/6 + 1x 2P16UL3/12 + 1x 2P16UL3/18 3x 2P16UL3/12 2x 2P16UL3/12 + 1x 2P16UL3/18 2x 2P16UL3/18	45	3x 3P16UL3/18
		40	1x 1P16UL3/6 + 2x 1P16UL3/18 2x 1P16UL3/12 + 1x 1P16UL3/18 1x 1P16UL3/12 + 2x 1P16UL3/18 3x 1P16UL3/18	34	1x 2P16UL3/6 + 1x 2P16UL3/12 + 1x 2P16UL3/18 2x 2P16UL3/12 + 1x 2P16UL3/18 2x 2P16UL3/18	48	3x 3P16UL3/18
		41	1x 1P16UL3/12 + 2x 1P16UL3/18 3x 1P16UL3/18	36	1x 2P16UL3/6 + 2x 2P16UL3/18 3x 2P16UL3/18 2x 2P16UL3/12 + 1x 2P16UL3/18 1x 2P16UL3/12 + 2x 2P16UL3/18		
		42	1x 1P16UL3/12 + 2x 1P16UL3/18 3x 1P16UL3/18				

Note: For detailed information and examples see page 20.

UM (V-EA) Series

UL508 Listed Manual Motor Controllers “Suitable as Motor Disconnect”

- DIN Rail Mounted
- 17.5mm width per pole
- Thermal Magnetic
- 0.3-60A / 480Y/277V AC, 50/60Hz
- 10kA Short Circuit Withstand Capacity
- Applications Include:
 - AC Motor Starting, Across the Line
 - AC General Use
 - AC Resistance
 - AC Discharge Lamps (Ballast)
 - AC Incandescent Lamps (Tungsten)



UL508 Listed
E137938



up to 25A
B,C,D curve



up to 25A
B,C,D curve



Current/ Voltage Rating	0.3-60A/480Y/277V AC 0.3-25A: 1 pole - 42V DC; 2 Pole - 80V DC 30-60A: 1 pole - 24V DC; 2 Pole - 60V DC
Short Circuit Withstand Rating (UL/CSA - Ratings)	0.3-60A (RC): 10kA with UL-listed RK5 back-up fuse or MCCB
Group Short Circuit Withstand Rating (UL/CSA - Ratings)	0.3-10A (RC): 10kA; 12-60A (RC): 5kA no branch circuit protection required
Interrupting Capacity (VDE - Ratings)	0.3-63A (RC): 10kA
Calibration Temperature	40°C (104°F)
Operating Temperature	-25°C to 55°C (-13°F to 131°F)
Storage Temperature	-40°C to 70°C (-40°F to 158°F)
Terminal Size Acceptability	Top: 18-3 AWG; Bottom: 18-2 AWG
Terminal Torque (min/max)	2 Nm (17.7 lb.in.) / 2.5Nm (22.2 lb.in)
Horse Power Ratings	see page 46
Mechanical Endurance Ratings	see page 47
Vibration Resistance	> 15g according to DIN EN 60069-2-59 during a load with $I_1 = 1.05 \times I_N$
Degree of protection acc. IEC/EN 60529	IP20
Mounting Orientation	In any plane

Short Circuit Withstand Ratings for UM (V-EA) Manual Motor Controller

Trip Curve	Amp Range	Backup Protection	UL-Listed RK5-Fuse up to 10kA	UL-Listed MCCB up to 10kA	No BCP Required up to:
all	0.3 - 10A		4xRC* min 15A, max 70A	4xRC* min 15A, max 70A	10kA
all	12 - 30/32A		4xRC* max 125A	4xRC* max 125A	5kA
all	40 - 50A		4xRC* max 200A	4xRC* max 200A	5kA
all	60 / 63A		4xRC* max 250A	4xRC* max 250A	5kA

*up to nearest rated current

Marking Details

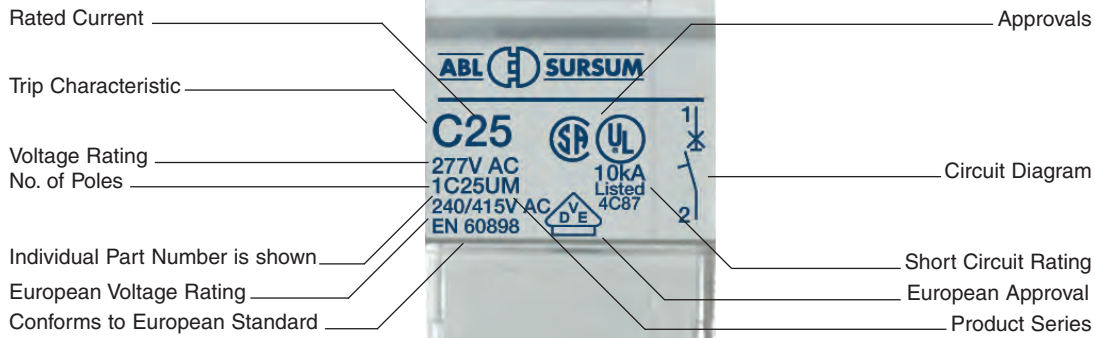

Dimensions in mm

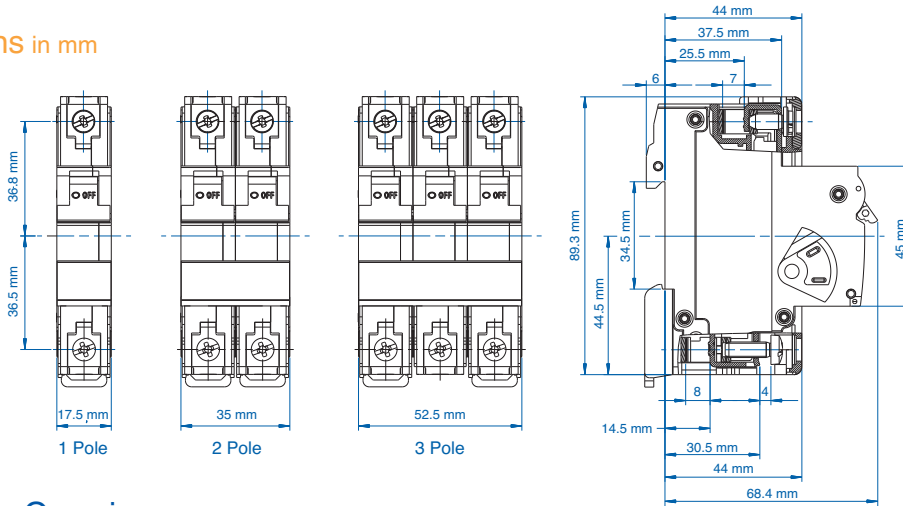

Application Overview

Trip-Characteristics*				Applications											
Characteristic Trip Boundaries				Lighting Wiring Protection Control Circuits	Business Equipment Appliances	Transformers	Power Supplies Heaters	Motors				General Electronics	Solenoid	Semi- conductors Components/ devices with low surge- current and short circuit withstand capabilities	Reactive Load
Thermal Trip		Magnetic Trip						General	Low Inrush	High Inrush	High Efficiency				
Must not Trip >100ms	Must Trip <1hr	Must not Trip >100ms	Must Trip at 100ms												
B-Characteristics				■	■					■					
1.13xRC	1.45xRC	3xRC	5xRC												
C-Characteristics				■	■			■							
1.13xRC	1.45xRC	5xRC	10xRC												
D-Characteristics						■	■		■					■	
1.13xRC	1.45xRC	10xRC	16xRC												
E-Characteristics						■	■			■					
1.05xRC	1.35xRC	14xRC	18xRC												
G-Characteristics				■		■		■	■			■			
1.05xRC	1.35xRC	8xRC	10xRC												
Z-Characteristics											■		■		
1.05xRC	1.35xRC	2xRC	3xRC												

*The value of each characteristic is shown vertically beneath its corresponding heading.



Warning!

This information should only be used as a selection guide. The use of a Miniature Circuit Breaker/Manual Motor Controller in an application with a certain Trip-Characteristic always requires prototype testing! It is the responsibility of the circuit design engineer to select the appropriate Miniature Circuit Breaker/Manual Motor Controller for his specific application.

UL 489

UL 508

UL 1077

UL 1077
Equipment Breakers

Earth Leakage
Circuit Breakers

ANNEX

V-EA Series B-Trip Characteristic

Application Examples:

Business equipment, wiring protection, lighting, appliances, control circuits, some motors and some electronic applications. Relatively long thermal trip delay but low magnetic trip point.



Standard Pack: 12

Weight:

0.3A - 32A

1.75kg (3.86 lb.)

40A - 63A

2.07kg (4.56 lb.)

One Pole

Rated Current	Type/ Voltage	Approvals
1.0A	1B1UM	UL SF
1.6A	1B1.6UM	UL SF
2.0A	1B2UM	UL SF
2.5A	1B2.5UM	UL SF
3.0A	1B3UM	UL SF
3.5A	1B3.5UM	UL SF
4.0A	1B4UM	UL SF
5.0A	1B5UM	UL SF
6.0A	1B6UM	UL SF
10A	1B10UM	UL SF
13A	1B13UM	UL SF
15A	1B15UM	UL SF
16A	1B16UM	UL SF
20A	1B20UM	UL SF
25A	1B25UZ	UL SF
30A	1B30UM	UL SF
32A	1B32UM	UL SF
40A	1B40UM	UL SF
50A	1B50UM	UL SF
60A	1B60UM	UL SF
63A	1B63UM	UL SF



Standard Pack: 4

Weight:

0.3A - 32A

1.75kg (3.86 lb.)

40A - 63A

2.07kg (4.56 lb.)

Three Pole

Rated Current	Type/ Cat. No.	Approvals
1.0A	3B1UM	UL SF
1.6A	3B1.6UM	UL SF
2.0A	3B2UM	UL SF
2.5A	3B2.5UM	UL SF
3.0A	3B3UM	UL SF
3.5A	3B3.5UM	UL SF
4.0A	3B4UM	UL SF
5.0A	3B5UM	UL SF
6.0A	3B6UM	UL SF
10A	3B10UM	UL SF
13A	3B13UM	UL SF
15A	3B15UM	UL SF
16A	3B16UM	UL SF
20A	3B20UM	UL SF
25A	3B25UM	UL SF
30A	3B30UM	UL SF
32A	3B32UM	UL SF
40A	3B40UM	UL SF
50A	3B50UM	UL SF
60A	3B60UM	UL SF
63A	3B63UM	UL SF



Standard Pack: 6

Weight:

0.3A - 32A

1.75kg (3.86 lb.)

40A - 63A

2.07kg (4.56 lb.)

Two Pole

Rated Current	Type/ Cat. No.	Approvals
1.0A	2B1UM	UL SF
1.6A	2B1.6UM	UL SF
2.0A	2B2UM	UL SF
2.5A	2B2.5UM	UL SF
3.0A	2B3UM	UL SF
3.5A	2B3.5UM	UL SF
4.0A	2B4UM	UL SF
5.0A	2B5UM	UL SF
6.0A	2B6UM	UL SF
10A	2B10UM	UL SF
13A	2B13UM	UL SF
15A	2B15UM	UL SF
16A	2B16UM	UL SF
20A	2B20UM	UL SF
25A	2B25UM	UL SF
30A	2B30UM	UL SF
32A	2B32UM	UL SF
40A	2B40UM	UL SF
50A	2B50UM	UL SF
60A	2B60UM	UL SF
63A	2B63UM	UL SF



Add-on Neutral Pole

Rated Current	Type/ Cat. No.	Approvals
0.3-63A/ 480Y/277V	N63UM	UL SF

Standard Pack: 6

Weight:

0.775kg (1.71lb.)

Standard Dual Connection Terminal

- Box clamp terminals
Top: 18-3 AWG;
Bottom: 18-2 AWG
(Line/Load reversible)
- Ring tongue terminals

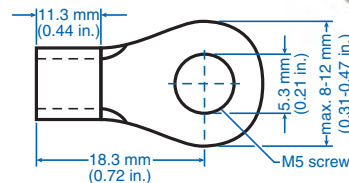
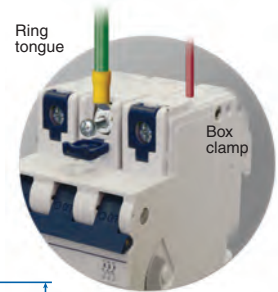

* May differ by manufacturer. Top terminal ring tongue max. thickness 1.6mm.

V-EA Series C-Trip Characteristic

Application Examples:

Low inrush motors, lighting, wiring protection, appliances, business equipment, and control circuit applications. Relatively long thermal trip delay and medium magnetic trip point.



Standard Pack: 12

Weight:
0.3A - 32A
1.75kg (3.86 lb.)
40A - 63A
2.07kg (4.56 lb.)

One Pole

Rated Current	Type/ Cat. No.	Approvals
0.3A	1C03UM	UL SP
0.5A	1C05UM	UL SP
0.75A	1C075UM	UL SP
1.0A	1C1UM	UL SP
1.6A	1C1.6UM	UL SP
2.0A	1C2UM	UL SP
2.5A	1C2.5UM	UL SP
3.0A	1C3UM	UL SP
3.5A	1C3.5UM	UL SP
4.0A	1C4UM	UL SP
5.0A	1C5UM	UL SP
6.0A	1C6UM	UL SP
8.0A	1C8UM	UL SP
10A	1C10UM	UL SP
13A	1C13UM	UL SP
15A	1C15UM	UL SP
16A	1C16UM	UL SP
20A	1C20UM	UL SP
25A	1C25UM	UL SP
30A	1C30UM	UL SP
32A	1C32UM	UL SP
40A	1C40UM	UL SP
50A	1C50UM	UL SP
60A	1C60UM	UL SP
63A	1C63UM	UL SP



Standard Pack: 4

Weight:
0.3A - 32A
1.75kg (3.86 lb.)
40A - 63A
2.07kg (4.56 lb.)

Three Pole

Rated Current	Type/ Cat. No.	Approvals
0.3A	3C03UM	UL SP
0.5A	3C05UM	UL SP
0.75A	3C075UM	UL SP
1.0A	3C1UM	UL SP
1.6A	3C1.6UM	UL SP
2.0A	3C2UM	UL SP
2.5A	3C2.5UM	UL SP
3.0A	3C3UM	UL SP
3.5A	3C3.5UM	UL SP
4.0A	3C4UM	UL SP
5.0A	3C5UM	UL SP
6.0A	3C6UM	UL SP
8.0A	3C8UM	UL SP
10A	3C10UM	UL SP
13A	3C13UM	UL SP
15A	3C15UM	UL SP
16A	3C16UM	UL SP
20A	3C20UM	UL SP
25A	3C25UM	UL SP
30A	3C30UM	UL SP
32A	3C32UM	UL SP
40A	3C40UM	UL SP
50A	3C50UM	UL SP
60A	3C60UM	UL SP
63A	3C63UM	UL SP



Standard Pack: 6

Weight:
0.3A - 32A
1.75kg (3.86 lb.)
40A - 63A
2.07kg (4.56 lb.)

Two Pole

Rated Current	Type/ Cat. No.	Approvals
0.3A	2C03UM	UL SP
0.5A	2C05UM	UL SP
0.75A	2C075UM	UL SP
1.0A	2C1UM	UL SP
1.6A	2C1.6UM	UL SP
2.0A	2C2UM	UL SP
2.5A	2C2.5UM	UL SP
3.0A	2C3UM	UL SP
3.5A	2C3.5UM	UL SP
4.0A	2C4UM	UL SP
5.0A	2C5UM	UL SP
6.0A	2C6UM	UL SP
8.0A	2C8UM	UL SP
10A	2C10UM	UL SP
13A	2C13UM	UL SP
15A	2C15UM	UL SP
16A	2C16UM	UL SP
20A	2C20UM	UL SP
25A	2C25UM	UL SP
30A	2C30UM	UL SP
32A	2C32UM	UL SP
40A	2C40UM	UL SP
50A	2C50UM	UL SP
60A	2C60UM	UL SP
63A	2C63UM	UL SP



Add-on Neutral Pole

Rated Current	Type/ Cat. No.	Approvals
0.3-63A/ 480Y/277V	N63UM	UL SP

Standard Pack: 6

Weight:
0.775kg (1.71lb.)

Standard Dual Connection Terminal

- Box clamp terminals
Top: 18-3 AWG;
Bottom: 18-2 AWG
(Line/Load reversible)
- Ring tongue terminals

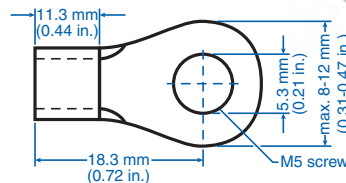
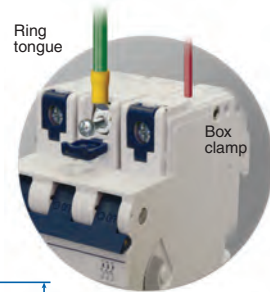

* May differ by manufacturer. Top terminal ring tongue max. thickness 1.6mm.

UL 489

UL 508

UL 1077

UL 1077
Equipment Breakers

Earth Leakage
Circuit Breakers

ANNEX

V-EA Series D-Trip Characteristic

Application Examples:

High inrush motors, transformers, power supplies, heaters and reactive loads. Relatively long thermal trip delay and very high magnetic trip point.



UL508 Listed
E137938



upto 25A
B,C,D curve



One Pole



Standard Pack: 12

Weight:

0.3A - 32A

1.75kg (3.86 lb.)

40A - 63A

2.07kg (4.56 lb.)

Rated Current	Type/ Cat. No.	Approvals
0.3A	1D03UM	UL SF
0.5A	1D05UM	UL SF
0.75A	1D075UM	UL SF
1.0A	1D1UM	UL SF
1.6A	1D1.6UM	UL SF
2.0A	1D2UM	UL SF
2.5A	1D2.5UM	UL SF
3.0A	1D3UM	UL SF
3.5A	1D3.5UM	UL SF
4.0A	1D4UM	UL SF
5.0A	1D5UM	UL SF
6.0A	1D6UM	UL SF
8.0A	1D8UM	UL SF
10A	1D10UM	UL SF
13A	1D13UM	UL SF
15A	1D15UM	UL SF
16A	1D16UM	UL SF
20A	1D20UM	UL SF
25A	1D25UM	UL SF
30A	1D30UM	UL SF
32A	1D32UM	UL SF
40A	1D40UM	UL SF
50A	1D50UM	UL SF
60A	1D60UM	UL SF
63A	1D63UM	UL SF

Three Pole



Standard Pack: 4

Weight:

0.3A - 32A

1.75kg (3.86 lb.)

40A - 63A

2.07kg (4.56 lb.)

Rated Current	Type/ Cat. No.	Approvals
0.3A	3D03UM	UL SF
0.5A	3D05UM	UL SF
0.75A	3D075UM	UL SF
1.0A	3D1UM	UL SF
1.6A	3D1.6UM	UL SF
2.0A	3D2UM	UL SF
2.5A	3D2.5UM	UL SF
3.0A	3D3UM	UL SF
3.5A	3D3.5UM	UL SF
4.0A	3D4UM	UL SF
5.0A	3D5UM	UL SF
6.0A	3D6UM	UL SF
8.0A	3D8UM	UL SF
10A	3D10UM	UL SF
13A	3D13UM	UL SF
15A	3D15UM	UL SF
16A	3D16UM	UL SF
20A	3D20UM	UL SF
25A	3D25UM	UL SF
30A	3D30UM	UL SF
32A	3D32UM	UL SF
40A	3D40UM	UL SF
50A	3D50UM	UL SF
60A	3D60UM	UL SF
63A	3D63UM	UL SF

Two Pole



Standard Pack: 6

Weight:

0.3A - 32A

1.75kg (3.86 lb.)

40A - 63A

2.07kg (4.56 lb.)

Rated Current	Type/ Cat. No.	Approvals
0.3A	2D03UM	UL SF
0.5A	2D05UM	UL SF
0.75A	2D075UM	UL SF
1.0A	2D1UM	UL SF
1.6A	2D1.6UM	UL SF
2.0A	2D2UM	UL SF
2.5A	2D2.5UM	UL SF
3.0A	2D3UM	UL SF
3.5A	2D3.5UM	UL SF
4.0A	2D4UM	UL SF
5.0A	2D5UM	UL SF
6.0A	2D6UM	UL SF
8.0A	2D8UM	UL SF
10A	2D10UM	UL SF
13A	2D13UM	UL SF
15A	2D15UM	UL SF
16A	2D16UM	UL SF
20A	2D20UM	UL SF
25A	2D25UM	UL SF
30A	2D30UM	UL SF
32A	2D32UM	UL SF
40A	2D40UM	UL SF
50A	2D50UM	UL SF
60A	2D60UM	UL SF
63A	2D63UM	UL SF

Add-on Neutral Pole



Rated Current	Type/ Cat. No.	Approvals
0.3-63A/ 480Y/277V	N63UM	UL SF

Standard Pack: 6

Weight:

0.775kg (1.71lb.)

Standard Dual Connection Terminal

- Box clamp terminals
Top: 18-3 AWG;
Bottom: 18-2 AWG
(Line/Load reversible)
- Ring tongue terminals

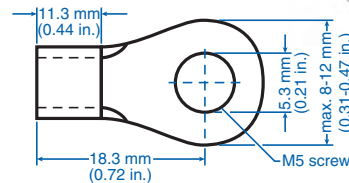
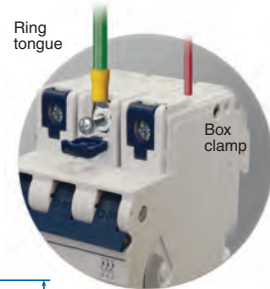

* May differ by manufacturer. Top terminal ring tongue max. thickness 1.6mm.

V-EA Series E-Trip Characteristic

Application Examples:

High efficiency motors, which have exceedingly high inrush currents. Relatively short thermal trip delays and very high magnetic trip points.



Standard Pack: 12

Weight:

0.3A - 32A
1.75kg (3.86 lb.)
40A - 63A
2.07kg (4.56 lb.)

One Pole

Rated Current	Type/ Cat. No.	Approvals
0.3A	1E03UM	UL SF
0.5A	1E05UM	UL SF
0.75A	1E075UM	UL SF
1.0A	1E1UM	UL SF
1.6A	1E1.6UM	UL SF
2.0A	1E2UM	UL SF
2.5A	1E2.5UM	UL SF
3.0A	1E3UM	UL SF
3.5A	1E3.5UM	UL SF
4.0A	1E4UM	UL SF
5.0A	1E5UM	UL SF
6.0A	1E6UM	UL SF
8.0A	1E8UM	UL SF
10A	1E10UM	UL SF
12A	1E12UM	UL SF
13A	1E13UM	UL SF
15A	1E15UM	UL SF
16A	1E16UM	UL SF
20A	1E20UM	UL SF
25A	1E25UM	UL SF
30A	1E30UM	UL SF
32A	1E32UM	UL SF
40A	1E40UM	UL SF
50A	1E50UM	UL SF
60A	1E60UM	UL SF
63A	1E63UM	UL SF



Standard Pack: 4

Weight:

0.3A - 32A
1.75kg (3.86 lb.)
40A - 63A
2.07kg (4.56 lb.)

Three Pole

Rated Current	Type/ Cat. No.	Approvals
0.3A	3E03UM	UL SF
0.5A	3E05UM	UL SF
0.75A	3E075UM	UL SF
1.0A	3E1UM	UL SF
1.6A	3E1.6UM	UL SF
2.0A	3E2UM	UL SF
2.5A	3E2.5UM	UL SF
3.0A	3E3UM	UL SF
3.5A	3E3.5UM	UL SF
4.0A	3E4UM	UL SF
5.0A	3E5UM	UL SF
6.0A	3E6UM	UL SF
8.0A	3E8UM	UL SF
10A	3E10UM	UL SF
12A	3E12UM	UL SF
13A	3E13UM	UL SF
15A	3E15UM	UL SF
16A	3E16UM	UL SF
20A	3E20UM	UL SF
25A	3E25UM	UL SF
30A	3E30UM	UL SF
32A	3E32UM	UL SF
40A	3E40UM	UL SF
50A	3E50UM	UL SF
60A	3E60UM	UL SF
63A	3E63UM	UL SF



Standard Pack: 6

Weight:

0.3A - 32A
1.75kg (3.86 lb.)
40A - 63A
2.07kg (4.56 lb.)

Two Pole

Rated Current	Type/ Cat. No.	Approvals
0.3A	2E03UM	UL SF
0.5A	2E05UM	UL SF
0.75A	2E075UM	UL SF
1.0A	2E1UM	UL SF
1.6A	2E1.6UM	UL SF
2.0A	2E2UM	UL SF
2.5A	2E2.5UM	UL SF
3.0A	2E3UM	UL SF
3.5A	2E3.5UM	UL SF
4.0A	2E4UM	UL SF
5.0A	2E5UM	UL SF
6.0A	2E6UM	UL SF
8.0A	2E8UM	UL SF
10A	2E10UM	UL SF
12A	2E12UM	UL SF
13A	2E13UM	UL SF
15A	2E15UM	UL SF
16A	2E16UM	UL SF
20A	2E20UM	UL SF
25A	2E25UM	UL SF
30A	2E30UM	UL SF
32A	2E32UM	UL SF
40A	2E40UM	UL SF
50A	2E50UM	UL SF
60A	2E60UM	UL SF
63A	2E63UM	UL SF



Add-on Neutral Pole

Rated Current	Type/ Cat. No.	Approvals
0.3-63A/ 480Y/277V	N63UM	UL SF

Standard Pack: 6

Weight:

0.775kg (1.71lb.)

Standard Dual Connection Terminal

- Box clamp terminals
Top: 18-3 AWG;
Bottom: 18-2 AWG
(Line/Load reversible)
- Ring tongue terminals

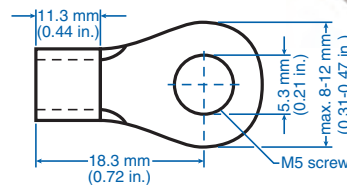
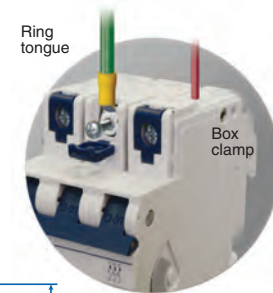

* May differ by manufacturer. Top terminal ring tongue max. thickness 1.6mm.

UL 489

UL 508

UL 1077

UL 1077
Equipment Breakers

Earth Leakage
Circuit Breakers

ANNEX

V-EA Series G-Trip Characteristic

Application Examples:

General industrial, including motors, some transformers, solenoids, control circuits, lighting and wiring. Meets the US trip norms with relatively short thermal trip delay and high magnetic trip point.



UL508 Listed
E137938



Standard Pack: 12

Weight:

0.3A - 32A

1.75kg (3.86 lb.)

40A - 63A

2.07kg (4.56 lb.)

One Pole

Rated Current	Type/ Cat. No.	Approvals
0.3A	1G03UM	UL SF
0.5A	1G05UM	UL SF
0.8A	1G08UM	UL SF
1.0A	1G1UM	UL SF
1.6A	1G1.6UM	UL SF
2.0A	1G2UM	UL SF
2.5A	1G2.5UM	UL SF
3.0A	1G3UM	UL SF
3.5A	1G3.5UM	UL SF
4.0A	1G4UM	UL SF
5.0A	1G5UM	UL SF
6.0A	1G6UM	UL SF
8.0A	1G8UM	UL SF
10A	1G10UM	UL SF
12A	1G12UM	UL SF
13A	1G13UM	UL SF
15A	1G15UM	UL SF
16A	1G16UM	UL SF
20A	1G20UM	UL SF
25A	1G25UM	UL SF
30A	1G30UM	UL SF
32A	1G32UM	UL SF
40A	1G40UM	UL SF
50A	1G50UM	UL SF
60A	1G60UM	UL SF
63A	1G63UM	UL SF



Standard Pack: 4

Weight:

0.3A - 32A

1.75kg (3.86 lb.)

40A - 63A

2.07kg (4.56 lb.)

Three Pole

Rated Current	Type/ Cat. No.	Approvals
0.3A	3G03UM	UL SF
0.5A	3G05UM	UL SF
0.8A	3G08UM	UL SF
1.0A	3G1UM	UL SF
1.6A	3G1.6UM	UL SF
2.0A	3G2UM	UL SF
2.5A	3G2.5UM	UL SF
3.0A	3G3UM	UL SF
3.5A	3G3.5UM	UL SF
4.0A	3G4UM	UL SF
5.0A	3G5UM	UL SF
6.0A	3G6UM	UL SF
8.0A	3G8UM	UL SF
10A	3G10UM	UL SF
12A	3G12UM	UL SF
13A	3G13UM	UL SF
15A	3G15UM	UL SF
16A	3G16UM	UL SF
20A	3G20UM	UL SF
25A	3G25UM	UL SF
30A	3G30UM	UL SF
32A	3G32UM	UL SF
40A	3G40UM	UL SF
50A	3G50UM	UL SF
60A	3G60UM	UL SF
63A	3G63UM	UL SF



Standard Pack: 6

Weight:

0.3A - 32A

1.75kg (3.86 lb.)

40A - 63A

2.07kg (4.56 lb.)

Two Pole

Rated Current	Type/ Cat. No.	Approvals
0.3A	2G03UM	UL SF
0.5A	2G05UM	UL SF
0.8A	2G08UM	UL SF
1.0A	2G1UM	UL SF
1.6A	2G1.6UM	UL SF
2.0A	2G2UM	UL SF
2.5A	2G2.5UM	UL SF
3.0A	2G3UM	UL SF
3.5A	2G3.5UM	UL SF
4.0A	2G4UM	UL SF
5.0A	2G5UM	UL SF
6.0A	2G6UM	UL SF
8.0A	2G8UM	UL SF
10A	2G10UM	UL SF
12A	2G12UM	UL SF
13A	2G13UM	UL SF
15A	2G15UM	UL SF
16A	2G16UM	UL SF
20A	2G20UM	UL SF
25A	2G25UM	UL SF
30A	2G30UM	UL SF
32A	2G32UM	UL SF
40A	2G40UM	UL SF
50A	2G50UM	UL SF
60A	2G60UM	UL SF
63A	2G63UM	UL SF



Add-on Neutral Pole

Rated Current	Type/ Cat. No.	Approvals
0.3-63A/ 480Y/277V	N63UM	UL SF

Standard Pack: 6

Weight:

0.775kg (1.71lb.)

Standard Dual Connection Terminal

- Box clamp terminals
Top: 18-3 AWG;
Bottom: 18-2 AWG
(Line/Load reversible)
- Ring tongue terminals

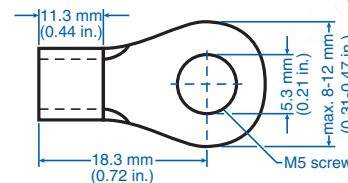
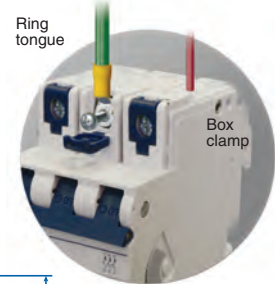

* May differ by manufacturer. Top terminal ring tongue max. thickness 1.6mm.

V-EA Series Z-Trip Characteristic

Application Examples:

Semiconductors, components which fail-short (vs. fail-open), and components/devices with low surge-current and short circuit withstand capabilities. Relatively short thermal delay and very low magnetic trip point.



UL508 Listed
E137938



UL 489

UL 508

UL 1077

UL 1077
Equipment Breakers

Earth Leakage
Circuit Breakers

ANNEX



Standard Pack: 12

Weight:

0.3A - 32A
1.75kg (3.86 lb.)
40A - 63A
2.07kg (4.56 lb.)

One Pole

Rated Current	Type/ Cat. No.	Approvals
0.3A	1Z03UM	UL SF
0.5A	1Z05UM	UL SF
0.75A	1Z075UM	UL SF
1.0A	1Z1UM	UL SF
1.6A	1Z1.6UM	UL SF
2.0A	1Z2UM	UL SF
2.5A	1Z2.5UM	UL SF
3.0A	1Z3UM	UL SF
3.5A	1Z3.5UM	UL SF
4.0A	1Z4UM	UL SF
5.0A	1Z5UM	UL SF
6.0A	1Z6UM	UL SF
8.0A	1Z8UM	UL SF
10A	1Z10UM	UL SF
12A	1Z12UM	UL SF
13A	1Z13UM	UL SF
15A	1Z15UM	UL SF
16A	1Z16UM	UL SF
20A	1Z20UM	UL SF
25A	1Z25UM	UL SF
30A	1Z30UM	UL SF
32A	1Z32UM	UL SF
40A	1Z40UM	UL SF
50A	1Z50UM	UL SF



Standard Pack: 4

Weight:

0.3A - 32A
1.75kg (3.86 lb.)
40A - 63A
2.07kg (4.56 lb.)

Three Pole

Rated Current	Type/ Cat. No.	Approvals
0.3A	3Z03UM	UL SF
0.5A	3Z05UM	UL SF
0.75A	3Z075UM	UL SF
1.0A	3Z1UM	UL SF
1.6A	3Z1.6UM	UL SF
2.0A	3Z2UM	UL SF
2.5A	3Z2.5UM	UL SF
3.0A	3Z3UM	UL SF
3.5A	3Z3.5UM	UL SF
4.0A	3Z4UM	UL SF
5.0A	3Z5UM	UL SF
6.0A	3Z6UM	UL SF
8.0A	3Z8UM	UL SF
10A	3Z10UM	UL SF
12A	3Z12UM	UL SF
13A	3Z13UM	UL SF
15A	3Z15UM	UL SF
16A	3Z16UM	UL SF
20A	3Z20UM	UL SF
25A	3Z25UM	UL SF
30A	3Z30UM	UL SF
32A	3Z32UM	UL SF
40A	3Z40UM	UL SF
50A	3Z50UM	UL SF



Standard Pack: 6

Weight:

0.3A - 32A
1.75kg (3.86 lb.)
40A - 63A
2.07kg (4.56 lb.)

Two Pole

Rated Current	Type/ Cat. No.	Approvals
0.3A	2Z03UM	UL SF
0.5A	2Z05UM	UL SF
0.75A	2Z075UM	UL SF
1.0A	2Z1UM	UL SF
1.6A	2Z1.6UM	UL SF
2.0A	2Z2UM	UL SF
2.5A	2Z2.5UM	UL SF
3.0A	2Z3UM	UL SF
3.5A	2Z3.5UM	UL SF
4.0A	2Z4UM	UL SF
5.0A	2Z5UM	UL SF
6.0A	2Z6UM	UL SF
8.0A	2Z8UM	UL SF
10A	2Z10UM	UL SF
12A	2Z12UM	UL SF
13A	2Z13UM	UL SF
15A	2Z15UM	UL SF
16A	2Z16UM	UL SF
20A	2Z20UM	UL SF
25A	2Z25UM	UL SF
30A	2Z30UM	UL SF
32A	2Z32UM	UL SF
40A	2Z40UM	UL SF
50A	2Z50UM	UL SF



Add-on Neutral Pole

Rated Current	Type/ Cat. No.	Approvals
0.3-63A/ 480Y/277V	N63UM	UL SF

Standard Pack: 6

Weight:

0.775kg (1.71lb.)

Standard Dual Connection Terminal

- Box clamp terminals
Top: 18-3 AWG;
Bottom: 18-2 AWG
(Line/Load reversible)
- Ring tongue terminals

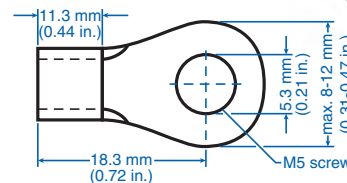
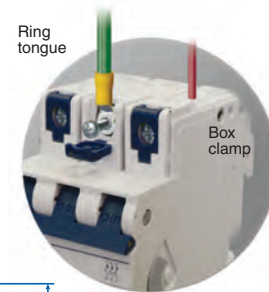

* May differ by manufacturer. Top terminal ring tongue max. thickness 1.6mm.

V-EA Trip Curves

B Trip Curve

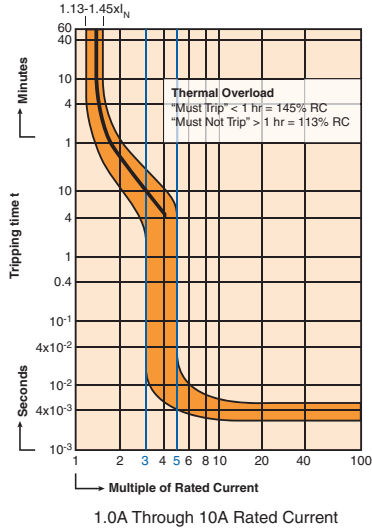

C Trip Curve

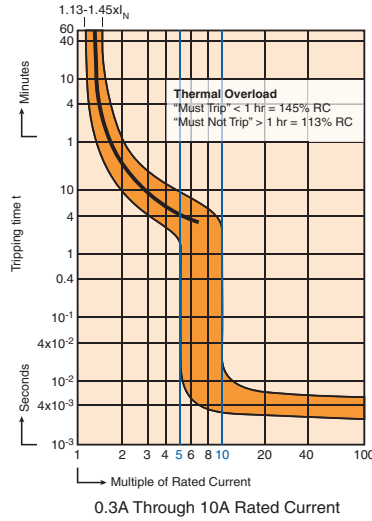

D Trip Curve

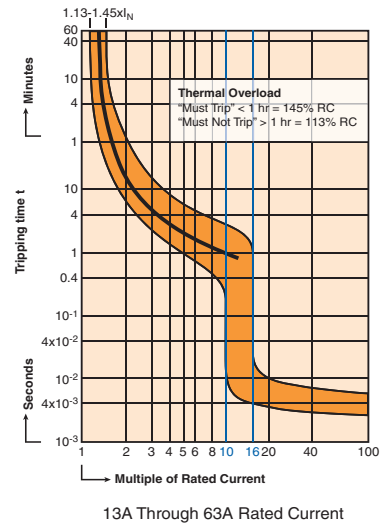
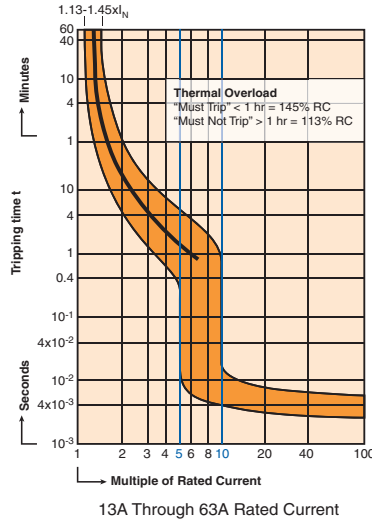
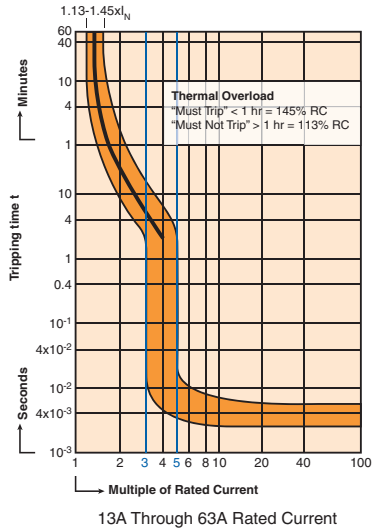
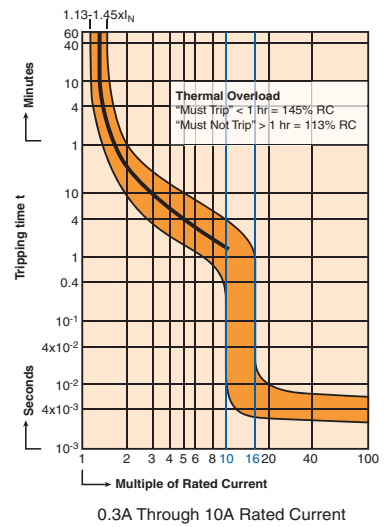

"B" Magnetic Trip Parameters

Rated current 1.0A to 63A.

1. Hold for a minimum of 100ms at surge of 3 times rated current.
2. Trip in under 100ms at 5 times rated current.

"C" Magnetic Trip Parameters

Rated current 0.3A to 63A.

1. Hold for a minimum of 100ms at surge of 5 times rated current.
2. Trip in under 100ms at 10 times rated current.

"D" Magnetic Trip Parameters

Rated current 0.3A to 63A.

1. Hold for a minimum of 100ms at surge of 10 times rated current.
2. Trip in under 100ms at 16 times rated current.

V-EA Trip Curves

E Trip Curve

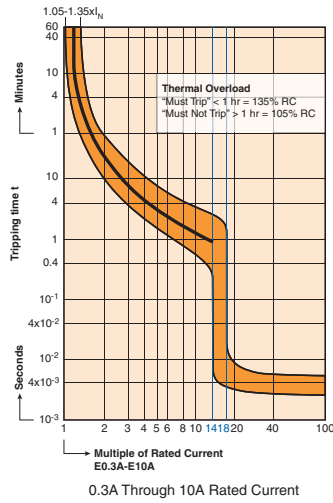

G Trip Curve

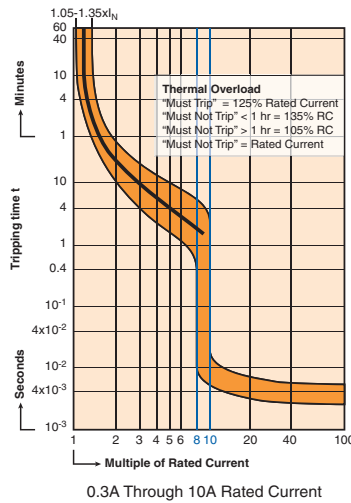

Z Trip Curve

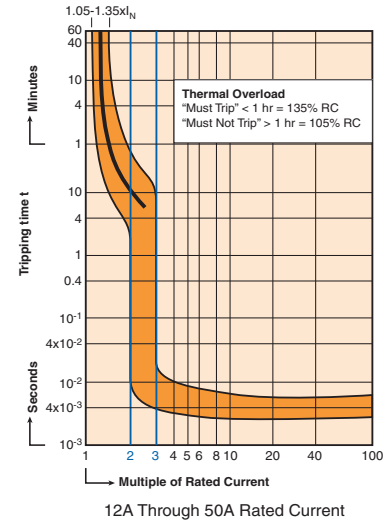
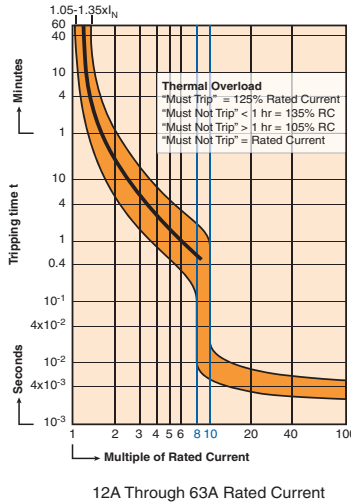
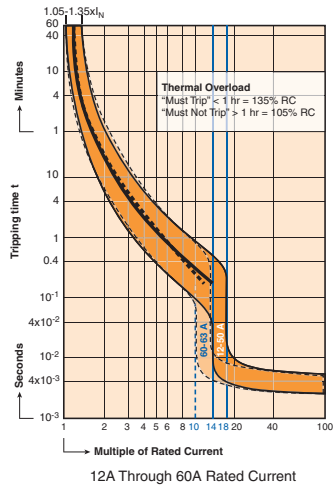
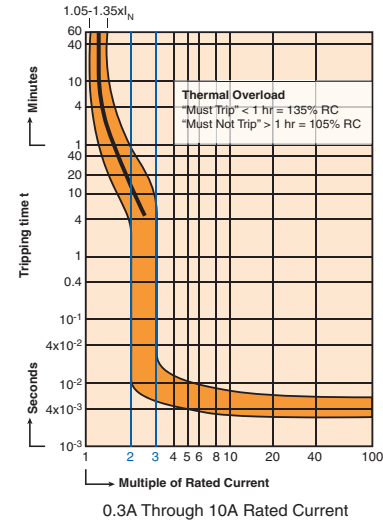

“E” Magnetic Trip Parameters
Rated Current, 0.3A to 50A,
60/63A (dotted line).

Magnetic Trip:

1. Hold for a minimum of 100ms at surge of 14 times (60A, 10 times) rated current.
2. Trip in under 100ms at 18 times (60A, 14 times) rated current.

“G” Magnetic Trip Parameters
Rated Current, 0.3A to 63A.

Magnetic Trip:

1. Hold for a minimum of 100ms at surge of 8 times rated current.
2. Trip in under 100ms at 10 times rated current.

“Z” Trip Parameters
Rated Current, 0.3A to 50A.

Magnetic Trip:

1. Hold for a minimum of 100ms at 2 times rated current.
2. Trip in under 100ms at 3 times rated current.

Table HP 1: AMPERE RATINGS & HORSEPOWER RATING 1 PHASE

			FLA & LRC CONVERTED TO TABLE HORSEPOWER (SEE NOTE #2) USE FLA & LRC RATINGS WHERE NO HP RATING IS GIVEN					
			NOMINAL CIRCUIT VOLTAGE					
V-EA RATED	MOTOR NAMEPLATE	MOTOR NAMEPLATE	110-120 VAC	200 VAC	208 VAC	220-240 VAC	265 VAC	277 VAC
CURRENT (SEE NOTE #1)	FLA RATING	STARTING/ LRC RATING						
0.30A 0.50A 0.75A	0.30A 0.50A 0.75A	1.80A 3.00A 4.35A						
0.80A 1.0A 1.6A	0.80A 1.0A 1.6A	4.8A 6.0A 9.6A						
2.0A 2.5A 3.0A	2.0A 2.5A 3.0A	12.0A 15.0A 18.0A		1/6hp 1/6hp	1/6hp 1/6hp	1/6hp 1/6hp 1/4hp	1/6hp 1/6hp 1/4hp	1/6hp 1/4hp 1/3hp
3.5A 4.0A	3.5A 4.0A	21.0A 24.0A		1/4hp 1/4hp	1/4hp 1/3hp	1/4hp 1/3hp	1/3hp 1/3hp	1/3hp 1/3hp
5.0A 6.0A 8.0A	5.0A 6.0A 8.0A	30.0A 36.0A 48.0A	1/6hp 1/4hp 1/3hp	1/3hp 1/2hp 3/4hp	1/2hp 1/2hp 3/4hp	1/2hp 1/2hp 1hp	1/2hp 3/4hp 1hp	1/2hp 3/4hp 1hp
10.0A	10.0A	60.0A	1/2hp	1hp	1hp	11/2hp	11/2hp	2hp
12.0A 12.5A	12.0A 12.5A	72.0A 75.0A	1/2hp 1/2hp	11/2hp 11/2hp	11/2hp 11/2hp	2hp 2hp	2hp 2hp	2hp 2hp
13.0A 15.0A 16.0A	13.0A 15.0A 16.0A	78.0A 90.0A 96.0A	1/2hp 3/4hp 1hp	11/2hp 2hp 2hp	11/2hp 2hp 2hp	2hp 2hp 2hp	2hp 3hp 3hp	2hp 3hp 3hp
20.0A 25.0A	20.0A 25.0A	120.0A 150.0A	11/2hp 2hp	3hp 3hp	3hp 3hp	3hp 3hp	3hp 5hp	3hp 5hp
30.0A	30.0A	180.0A	2hp	3hp	3hp	5hp	5hp	5hp
32.0A	32.0A	192.0A	2hp	3hp	5hp	5hp	5hp	5hp
40.0A	40.0A	240.0A	3hp	5hp	71/2hp	71/2hp	71/2hp	71/2hp
50.0A 60.0A	50.0A 60.0A	300.0A 360.0A	3hp 5hp	71/2hp 10hp	10hp 10hp	10hp 10hp	10hp 10hp	10hp 15hp

NOTE #1: For AC motor circuit nameplate full load current, AC general-use loads, AC resistance loads, AC incandescent lamp (tungsten) loads, AC electric discharge lamp (ballast) loads.
NOTE #2: Conversions per UL508® Table 45.2 and NFPA-70: National Electrical Code® 2011 Tables 430-248 and 430-251(A).

TABLE HP 2: AMPERE RATING & HORSEPOWER RATING 3 PHASE & 2 PHASE - 4 WIRE

FLA & LRC RATINGS CONVERTED TO TABLE HORSEPOWER (SEE NOTE #2) USE FLA & LRC RATINGS WHERE NO HP IS LISTED														
V-EA RATED CURRENT (SEE NOTE #1)	MOTOR NAMEPLATE FLA RATING	MOTOR NAMEPLATE STARTING/ LRC RATING	110-120 VAC				200 VAC		208 VAC		220-240 VAC (SEE NOTE #3)		440-480 VAC	
			Motor Design				Motor Design		Motor Design		Motor Design		Motor Design	
			B, C, D	E			B, C, D	E	B, C, D	E	B, C, D	E	B, C, D	E
0.30A 0.50A 0.75A	0.30A 0.50A 0.75A	3.0A 5.0A 7.5A												
0.80A 1.0A 1.6A	0.80A 1.0A 1.6A	8.0A 10.0A 16.0A										1/2hp	1/2hp	
2.0A 2.5A 3.0A	2.0A 2.5A 3.0A	20.0A 25.0A 30.0A			1/2hp 1/2hp	1/2hp 1/2hp	1/2hp 1/2hp	1/2hp 1/2hp	1/2hp 1/2hp	1/2hp 1/2hp	1/2hp 1/2hp	3/4hp 1hp 11/2hp	3/4hp 1hp 11/2hp	
3.5A 4.0A	3.5A 4.0A	35.0A 40.0A			1/2hp 3/4hp	1/2hp 3/4hp	3/4hp 3/4hp	3/4hp 3/4hp	3/4hp 3/4hp	3/4hp 3/4hp	3/4hp 3/4hp	2hp 2hp	2hp 2hp	
5.0A 6.0A 8.0A	5.0A 6.0A 8.0A	42.0A 50.4A 67.2A	1/2hp 1/2hp 3/4hp	1/2hp 1/2hp 3/4hp	1hp 1hp 2hp	1hp 1hp 2hp	1hp 1hp 2hp	1hp 1hp 2hp	1hp 1hp 2hp	11/2hp 11/2hp 2hp	1hp 11/2hp 2hp	3hp 3hp 5hp	3hp 3hp 5hp	
10.0A 12.0A 12.5A	10.0A 12.0A 12.5A	84.0A 100.8A 105.0A	1hp 11/2hp 11/2hp	1hp 11/2hp 11/2hp	2hp 3hp 3hp	2hp 3hp 3hp	2hp 3hp 3hp	2hp 3hp 3hp	2hp 3hp 3hp	3hp 3hp 3hp	3hp 3hp 3hp	5hp 71/2hp 71/2hp	5hp 71/2hp 71/2hp	
13.0A 15.0A 16.0A	13.0A 15.0A 16.0A	109.2A 126.0A 134.4A	11/2hp 2hp 2hp	11/2hp 2hp 2hp	3hp 3hp 3hp	3hp 3hp 3hp	3hp 3hp 3hp	3hp 3hp 3hp	3hp 3hp 3hp	3hp 3hp 5hp	3hp 3hp 5hp	71/2hp 10hp 10hp	71/2hp 10hp 10hp	
20.0A 25.0A	20.0A 25.0A	168.0A 210.0A	3hp 3hp	3hp 3hp	5hp 5hp	5hp 5hp	5hp 71/2hp	5hp 71/2hp	5hp 71/2hp	5hp 71/2hp	5hp 71/2hp	10hp 15hp	10hp 15hp	
30.0A 32.0A 40.0A	30.0A 32.0A 40.0A	252.0A 268.8A 226.0A	5hp 5hp 5hp	5hp 5hp 5hp	5hp 5hp 10hp	5hp 5hp 10hp	71/2hp 10hp 10hp	71/2hp 10hp 10hp	10hp 10hp 10hp	10hp 10hp 10hp	10hp 10hp 10hp	20hp 20hp 30hp	20hp 20hp 20hp	
50.0A 60.0A	50.0A 60.0A	282.5A 339.0A	71/2hp 10hp	71/2hp 10hp	15hp 15hp	10hp 10hp	15hp 20hp	10hp 10hp	15hp 20hp	10hp 15hp	10hp 15hp	30hp 40hp	25hp 30hp	

NOTE #1: For AC motor circuit nameplate full load current, AC general-use loads, AC resistance loads, AC incandescent lamp (tungsten) loads, AC electric discharge lamp (ballast) loads.
NOTE #2: Conversions per UL508® proposed Tables 45.2 and 45.4 and NFPA-70: National Electrical Code® 2011 Tables 430-249, 430-250 and 430-251(B).

V-EA INTERNAL RESISTANCE

Rated Current (Amp)	Trip Characteristic					
	B (Ohms)	C (Ohms)	D (Ohms)	E (Ohms)	G (Ohms)	Z (Ohms)
0.3	—	16.8620	16.8620	14.52000	16.8620	31.5060
0.5	—	6.8540	6.0009	5.92000	6.8540	10.2460
0.75/0.8	—	3.0540	3.0540	2.70000	3.0540	5.3920
1.0	—	1.7000	1.7560	1.48000	1.7560	2.6910
1.6	—	0.5870	0.5870	0.57400	0.5870	0.9440
2.0	—	0.4190	0.4190	0.40500	0.4190	0.8900
2.5	—	0.2950	0.2950	0.26900	0.2950	0.4290
3.0	—	0.2020	0.2020	0.18600	0.2020	0.3460
3.5	—	0.1390	0.1390	0.13900	0.1390	0.1790
4.0	—	0.1090	0.1090	0.10600	0.1090	0.1620
5.0	—	0.0654	0.0654	0.05900	0.0654	0.1050
6.0	0.0528	0.0528	0.0491	0.04600	0.0491	0.0823
8.0	—	0.0278	0.0240	0.03040	0.0333	0.0371
10	0.0216	0.0216	0.0187	0.02020	0.0211	0.0278
12/12.5	—	—	—	0.00724	0.0084	0.0151
13	0.0113	0.0084	0.0085	0.00724	0.0084	0.0151
15/16	0.0085	0.0085	0.0076	0.00731	0.0076	0.0114
20	0.0067	0.0067	0.0064	0.00582	0.0064	0.0075
25	0.0050	0.0050	0.0041	0.00411	0.0046	0.0050
30/32	0.0032	0.0032	0.0027	0.00272	0.0030	0.0032
40	0.0025	0.0025	0.0022	0.00212	0.0022	0.0022
50	0.0019	0.0019	0.0018	0.00184	0.0019	0.00195
60/63	0.0018	0.0018	0.0017	0.00172	0.00179	—

Resistances listed are “hot” values, as opposed to cold start values. Operating voltage drop across the V-EA and power loss per pole can be approximated with basic formulas:

$$V_{DROD} = I_{OPERATING} \times R_{TABLE}$$

$$P_{LOSS P/P} = I_{OPERATING}^2 \times R_{TABLE}$$

Voltage drops should be reviewed when V-EAs with high internal resistance are used (e.g., load voltage minimums). Power loss should be reviewed when V-EAs with high rated currents are used (e.g., enclosure heating).

The listed V-EA internal resistance values should not be used in calculations of available short-circuit current downstream of the V-EA. The dynamic impedance of the V-EA under short-circuit conditions can vary significantly from internal resistance values in normal operation.

LINE CURRENT FREQUENCY EFFECTS ON TRIP CURVES

Frequency Effects on Magnetic Trip Curves					
Trip Curve	Trip Zone At 16 2/3 - 60Hz (x RC)	Trip Zone At 100 Hz (x RC)	Trip Zone At 200 Hz (x RC)	Trip Zone At 400 Hz (x RC)	Trip Zone At DC (x RC)
Z	2 - 3	2.2 - 3.3	2.4 - 3.6	2.8 - 4.2	3.0 - 4.5
B	3 - 5	3.3 - 5.5	3.6 - 6.0	4.2 - 7.0	4.5 - 7.5
C	5 - 10	5.5 - 11.0	6.0 - 12	7.0 - 14.0	7.5 - 15.0
G	8 - 10	8.8 - 11.0	9.6 - 12.0	11.2 - 14.0	12.0 - 15.0
D	10 - 16	11.0 - 17.6	12.0 - 19.2	14.0 - 22.4	15.0 - 24.0
E	14 - 18	15.4 - 19.8	16.8 - 21.6	19.6 - 25.2	21.0 - 27.0

The thermal trip is not affected by the frequency of the line current. The magnetic trip is within the trip zone of the characteristic curve for frequencies from 16 2/3 to 60Hz. At lower and higher frequencies, the magnetic trip will be delayed longer than indicated by the characteristic curve, roughly as follows:

- At 100Hz: Mag. Trip Current = 1.1 x curve current
- At 200Hz: Mag. Trip Current = 1.2 x curve current
- At 400Hz: Mag. Trip Current = 1.4 x curve current
- At DC: Mag. Trip Current = 1.5 x curve current

For example, at 16 2/3 - 60 Hz the magnetic trip zone for the “G” characteristic is 8 to 10 times the rated current of the specific V-EA (i.e., hold for at least 100ms at 8 x RC, trip in less than 100ms at 10 x RC). With a 400Hz current, a magnetic trip at 10 x RC would be greatly delayed (thermal would likely trip first), as the magnetic trip zone is now 11.2 to 14 x RC. If a quicker magnetic trip is required with 400Hz, the “B” or “C” characteristic should be considered.

MECHANICAL ENDURANCE RATINGS (ON/OFF OPERATIONS)

Application	2 x (1.15 x RC)	2 x RC	RC	No Load	Total
AC General Use	—	6,000	—	4,000	10,000
AC Motor Starting Across the Line	1,000	—	5,000	4,000	10,000
AC Incandescent Lamps (Tungsten)	—	—	6,000	4,000	10,000
AC Electrical Discharge Lamps (Ballast)	—	6,000	—	4,000	10,000
AC Resistance	—	6,000	—	4,000	10,000

Manufacturers self certification 20000 ON/OFF operations with no load

UL 489

UL 508

UL 1077

UL 1077
Equipment Breakers

Earth Leakage
Circuit Breakers

ANNEX

MA-Series

Three Phase Adjustable Trip Miniature Circuit Breakers/ Manual Motor Controllers

The MA was designed to handle the high inrush loads of 3 phase transformers, power supplies, motors, etc. The MA protects wiring and equipment from damage caused by the three major classes of over-current, yet greatly reduces the number of nuisance trips in high starting and inrush current circuits.

An IEC device with excellent ratings under a UL listing at 480Y/277V (including group ratings) and at 500V under international standards, the Altech/ABL Sursum MA provides short and long term cost effective circuit protection for USA and/or export applications. The short term advantages include: (1) adjustable thermal trip allows finalization of initial designs before procurement of the load equipment is complete; (2) snap-on mounting for readily available, internationally standardized DIN Rail saves panel layout design time as well as installation and change labor; (3) large cage-clamp terminals with screws suitable to power screwdrivers, simplifies and speeds wiring; (4) convenient switched disconnect during factory testing and/or initial start-up saves time and aggravation. The key long term advantage is customer satisfaction and proven over-current protection of wiring and equipment (and the lack of rework/repair costs).



UL508 listed
E137938



CAN/CSA-C22.2 No.14 certified



Type Designation

MA 16 U M
(a) (b) (c) (d)

- (a) = MA - Manual Motor Controller
(b) = Rated Current
(c) = U - US Housing
= R - US Housing + Ring Tongue
(d) = M - Part No. Designation

Voltage Rating	480Y/277V AC
AIC (Interrupt Capacity)	0.16A-2.5A: 42kA; 4.0A-16A: 14kA; 20A-40A: 10kA
Standard Short Circuit Withstand Rating (UL/CSA Ratings)	0.16A-2.5A: 42kA; 4.0A-16A: 14kA; 20A-40A: 10kA
Group Short Circuit Ratings (UL/CSA Ratings)	see above
Typical Life	6,000 on/off operations with 2xRC
Calibration Temperature	25°C, +0°, -5° (77°F, +0° -9°)
Standard Pack and Weight	1/450g (1.0 lb.)
Terminal Size Acceptability	Top/Bottom: 18-3 AWG
Terminal Torque (min/max)	2 Nm (17.7 lb.in.) / 2.5Nm (22.2 lb.in)

Cat. No.	Rated Current	FLA Dial Adjustment Markings	GROUP SHORT CIRCUIT RATING AT 480VAC ^a (and BCP size)	3Ø HORSEPOWER RATINGS AT NOMINAL LINE VOLTAGE (See Note for HEA Definition)				
				110-120V HP (HEA)	200V HP (HEA)	208V HP (HEA)	220-240V HP (HEA)	460-480V HP (HEA)
MA016UM	0.16A	0.1/ 0.12/0.14/0.16	42kARMS symmetrical (max. 1200A MCCB or RK5)					
MA025UM	0.25A	0.16/0.19/0.22/0.25						
MA040UM	0.40A	0.25/0.30/0.35/0.40						
MA063UM	0.63A	0.40/0.48/0.56/0.63						
MA1.0UM	1.0A	0.63/0.75/0.87/1.0						
MA1.6UM	1.6A	1.0/1.2/1.4/1.6						
MA2.5UM	2.5A	1.6/1.9/2.2/2.5						
MA4.0UM	4.0A	2.5/3.0/3.5/4.0	14kARMS symmetrical (max. 350A MCCB or RK5)	1/2 (4.0)	3/4 (3.2)	3/4 (3.1)	1 (3.6)	2 (3.42)
MA6.3UM	6.3A	4.0/4.8/5.6/6.3		3/4 (5.6)	1 1/2 (6.0)	1 1/2 (5.7)	1 1/2 (5.2)	3 (4.8)
MA10UM	10A	6.3/7.5/8.7/10		1 (7.2)	2 (7.8)	2 (7.5)	3 (9.6)	5 (7.6)
MA16UM	16A	10/12/14/16	10kARMS symmetrical (max. 350A MCCB or RK5)	2 (13.6)	3 (11.0)	3 (10.6)	5 (15.2)	10 (14.0)
MA20UM	20A	16/17/18.5/20		3 (19.2)	5 (17.5)	5 (16.7)	5 (15.2)	10 (14.0)
MA25UM	25A	20/21.5/23/25		3 (19.2)	5 (17.5)	7 1/2 (24.2)	7 1/2 (22.0)	15 (21.0)
MA32UM	32A	25/27/30/32		5 (30.4)	7 1/2 (25.0)	7 1/2 (24.2)	10 (28.0)	20 (27.0)
MA40UM	40A	32/34/37/40		5 (30.4)	10 (32.0)	10 (31.0)	10 (28.0)	25 (34.0)

Note: HEA - Horsepower Equivalent Amperes, the nominal amperage assigned to standard motor horsepower ratings in design guide tables such as NFPA-70 Tables 430-248, 430-249, 430-250; UL1077 Table 16.2; CSA - C22.2 No. 235-M89 Tables 44 and 45; CSA-C22.2 No. 14-M91 Table 19, etc. Multiply HEA values (in parenthesis) by 1.1 if power factor is 90%, and by 1.2 if power factor is 80%.

^a The standard-circuit short-circuit rating is 14kA for all types. Group ratings can be used in a standard circuit (e.g., MA1.0U at 42kA), but a higher standard rating cannot be used in a group circuit (e.g., MA40U at 14kA only in standard circuit.)

Dimensions in mm

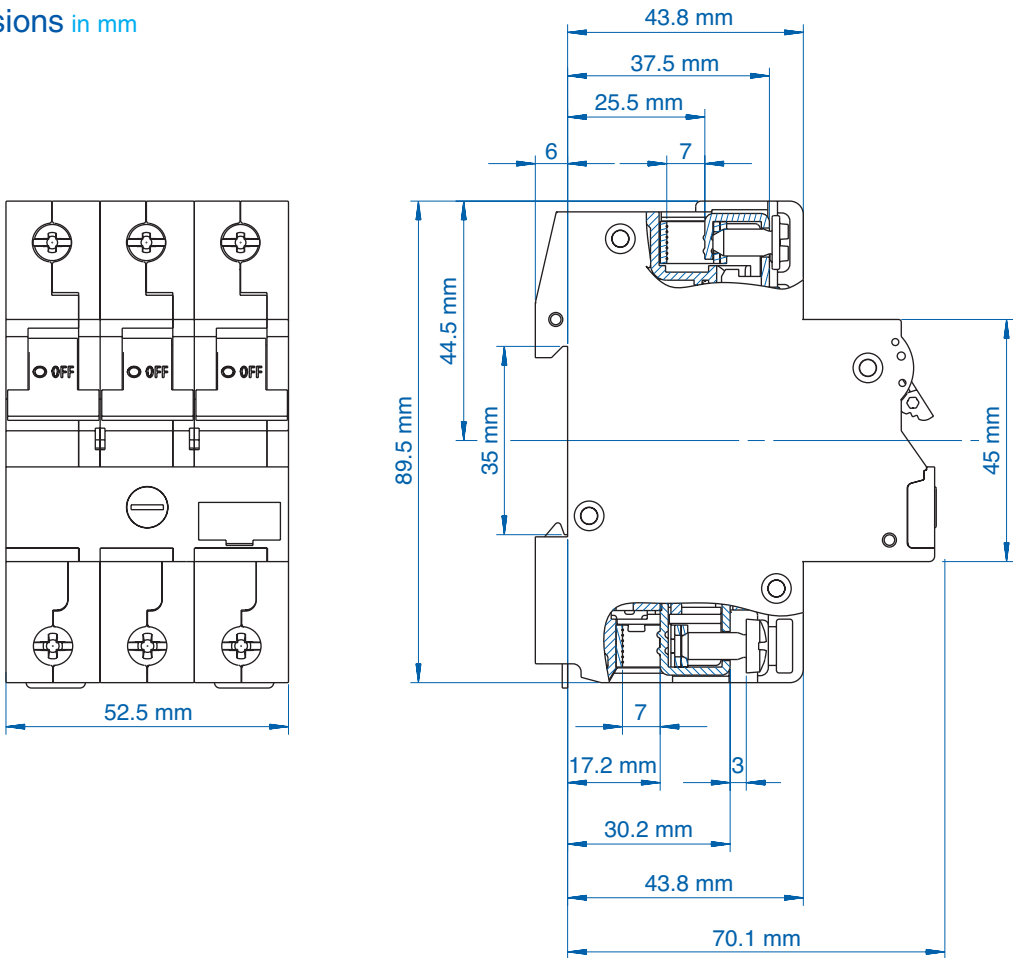

MA- Series Trip Curves

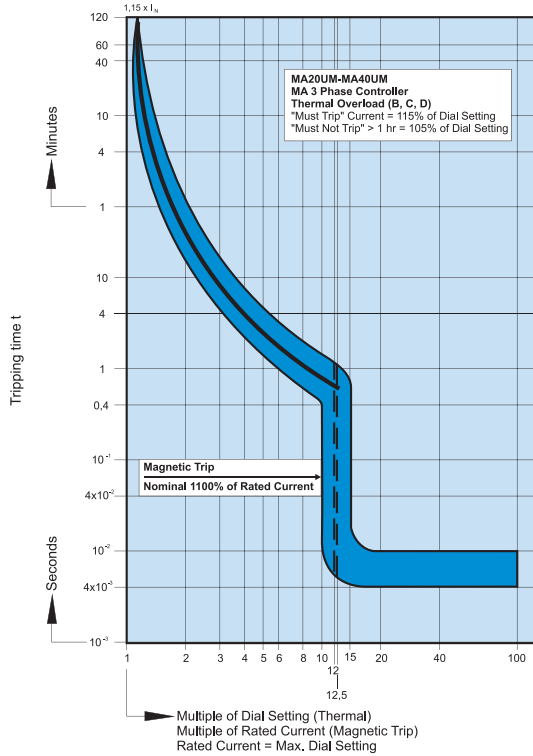
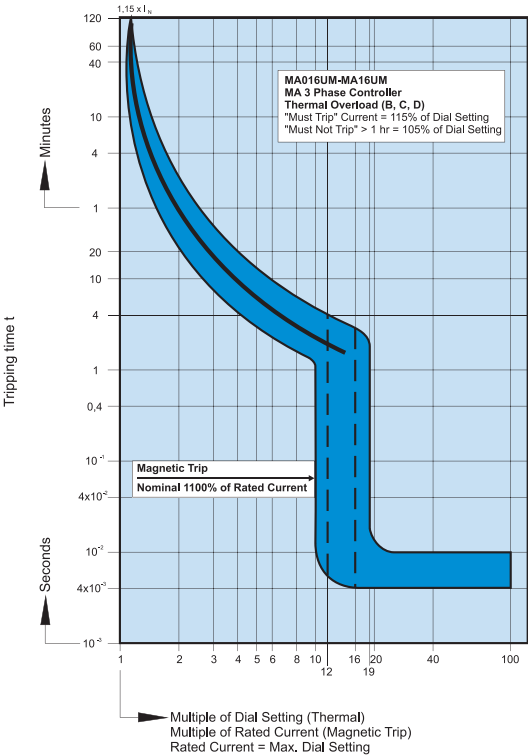

MA/USA Manual Motor Controller

UL 489

UL 508

UL 1077

UL 1077
Equipment Breakers

Earth Leakage
Circuit Breakers

ANNEX

UM (V-EA) and MA Accessories

For mounting instructions please refer to page 43.



Auxiliary Contact, Alarm Switch



Type/ Cat No.	Description	Contacts Type	Std Pk
H10UM	1 Auxiliary Contact	1NO	6
H11UM	2 Auxiliary Contacts	1NO + 1NC	6
H12UM	3 Auxiliary Contacts	1NO + 2NC	6
H21UM	3 Auxiliary Contacts	2NO + 1NC	6
HLS11M*	1 Auxiliary/1 Signal Contacts	1CO + 1CO (Signal)	6

Rated Operating Currents	10A @ 240V AC 3A @ 110V DC 1A @ 220V DC
Minimum Contact Load	1mA @ 24V DC
Torque	max. 0.8Nm (7 lb.in)

Wire Range:

Single Wire	1.0mm ² - 2.5mm ² (18-14 AWG)
Stranded Wire	1.0mm ² - 1.5mm ² (18-16 AWG)
Stranded Wire with Ferrule	1.0mm ² - 1.5mm ² (18-16 AWG)

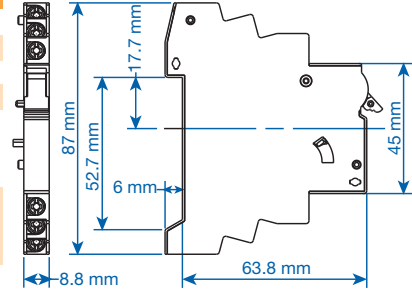

Shunt Trip



Type/ Cat No.	Rated Voltage U _N	Max. Operating Current @ U _N	Std Pk
FA12UM	12V AC/DC	1.3A	5
FA24UM	24V AC/DC	0.6A	5
FA48UM	48 - 72V AC/DC	0.2A	5
FA110UM	110 - 240V AC/DC, 277V AC	0.25A @ 110V 0.5A @ 240V 0.58A @ 277V	5

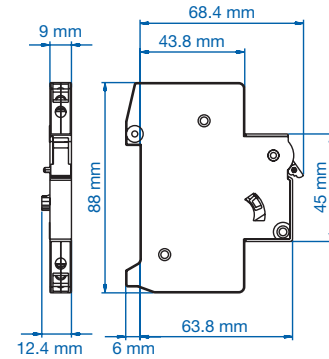

Undervoltage Trip*



Type/ Cat No.	Line Voltage V _E	Std Pk
UA120UM	120V AC, 60Hz	5

Reset-Hold Voltage = 0.85 x V_E
Drop-Out Voltage = 0.35 ~ 0.7 x V_E

V_E = Rated Voltage

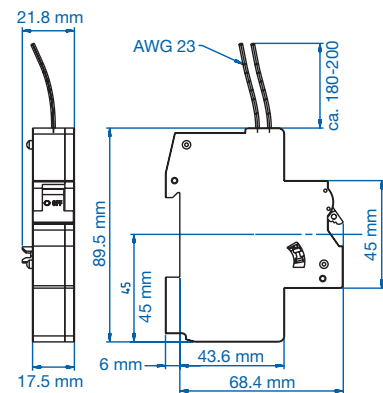

* Not UL approved. ** UM (V-EA) and MA can also be locked in the on and off position by simply using a common lead or meter seal, which gets fed through the hole in the handle and a corresponding hole in the housing.

UM (V-EA) and MA Accessories

For mounting instructions please refer to page 43.



Neutral Pole

Type/ Cat No.	Rated Current I_N	Rated Voltage U_N	Std Pk
N63UM	0.3 - 63A	480Y/277V AC	6

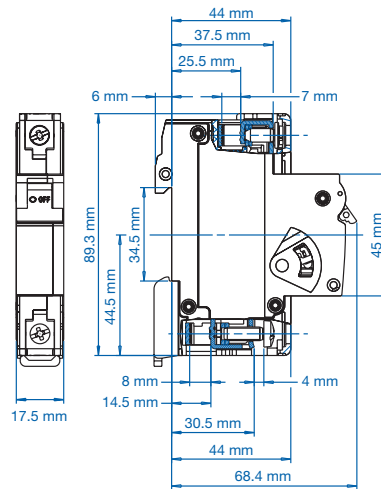

Dimensions N63UM, FxUM.



Touch Protection Caps

to cover the terminal screw holes on the switching devices, neutral Poles and shunt trips for increased touch protection.

Type/ Cat No.	Std Pk
BS.UL	100

Cooling Spacer



Type/ Cat No.	Std Pk
15.960	1



Mounting Screw 34mm

to connect the auxiliary contact and shunt trip or neutral Pole to the circuit breaker.

Type/ Cat No.	Std Pk
E983419	10



Lock-out Adapter**

Type/ Cat No.	Std Pk
EASS	10

UL 489

UL 508

UL 1077

UL 1077
Equipment Breakers

Earth Leakage
Circuit Breakers

ANNEX

MS-Series Three Phase Adjustable Trip Economy Manual Motor Controllers

with overload and short circuit protection,
phase failure sensitivity according to
IEC 947-4-1, DIN VDE 0660 Part 102



Type Designation

MS 016
(a) (b)

(a) = MS - Manual Motor
Controller

(b) = Rated Current

Type/ Cat. No.	Rated Current	Overload release adjustment/FLA (A)	Instantaneous setting (A)	3Ø Horsepower Rating				
				115V	200V	230V	480V	600V
MS016	0.16	0.1 - 0.16	1.92	Ampere rated for motor circuits having a full-load-amperage (FLA) not exceeding the MS's general purpose rated current and a locked rotor current not exceeding 6 times the MS's rated current.				
MS025	0.25	0.16 - 0.25	3					
MS04	0.4	0.25 - 0.4	4.8					
MS063	0.63	0.4 - 0.63	7.6					
MS1	1.0	0.63 - 1	12	-	-	-	1/2hp	1/2hp
MS1.6	1.6	1 - 1.6	19.2	-	-	-	3/4hp	1hp
MS2.5	2.5	1.6 - 2.5	30	-	1/2hp	1/2hp	1hp	1 1/2hp
MS4	4.0	2.5 - 4	48	1/2hp	3/4hp	1hp	2hp	3hp
MS6.3	6.3	4 - 6.3	75.6	3/4hp	1 1/2hp	1 1/2hp	3hp	5hp
MS10	10.0	6.3 - 10	120	1hp	2hp	3hp	5hp	7 1/2hp
MS16	16.0	10 - 16	192	2hp	3hp	5hp	10hp	10hp
MS20	20.0	16 - 20	240	3hp	5hp	7 1/2hp	15hp	-
MS25	25.0	20 - 25	300	3hp	5hp	7 1/2hp	15hp	-

Maximum Voltage	600V AC (MS20 and MS25, 480V AC)
Short Circuit Withstanding Rating (UL/CSA Rating)	5kA
Group Short Circuit Withstanding Rating (UL/CSA Rating)	5kA
Interrupting Capacity (VDE - Ratings)	0.16-6.3A: Self protected 10-25A: 6kA
Mechanical Endurance	10,000 on/off operations
Standard Pack and Weight	1/250g (0.55lb)
Terminal Size Acceptability	14-10 AWG
Terminal Torque	1.8Nm (16lb. in.)

Dimensions

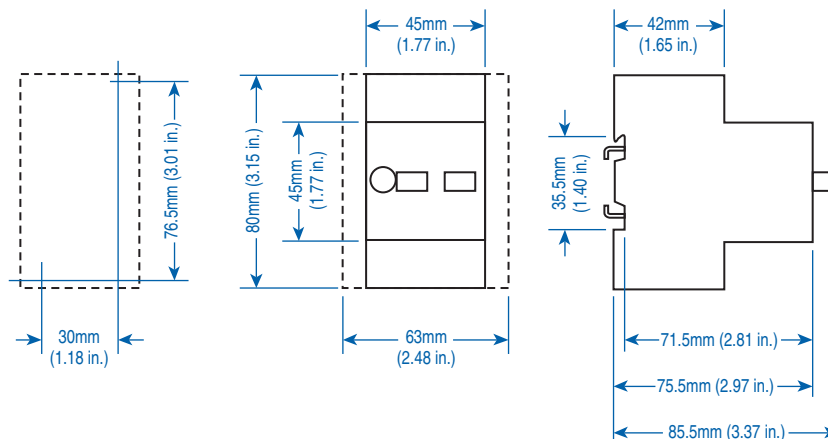

With its high breaking capacity and current limitation the MS Manual Motor Controllers provide optimum protection for electrical motors as well as for other consumer units up to 25 amps. They are equipped with phase failure sensitivity, isolating and main switch functions. 13 ranges cover nominal rated currents from 0.1 up to 25 amps. The MS's are temperature compensated; the trip current of the magnetic part is $12 \times I_n$. The Manual Motor Controllers are built in accordance with IEC 947.

Accessories

MS Three Phase
Adjustable Trip Economy
Manual Motor Controllers



**Auxiliary contact blocks for side mounting
(3.5A/230V AC; 2A/400V AC)**

Width mm	Contacts	Type/ Cat. No.	Weight g/pc.	Std. Pk.
9	2NO	HMS20	40	10
9	1NO + 1NC	HMS11	40	10
9	1NO	HMS10	35	10
9	2NC	HMS02	40	10
9	1NC	HMS01	35	10

UL 489

UL 508

UL 1077

UL 1077
Equipment Breakers

Earth Leakage
Circuit Breakers

ANNEX



Insulated Enclosure IP55
with integrated PE(N) terminal;
top and bottom each have 2
metric knock-outs

Type/ Cat. No.	Weight g/pc.	Std. Pk.
MS.G55	240	1



Emergency-Stop
twist or key to release,
red on yellow background

Release Type	Type/ Cat. No.	Weight g/pc.	Std. Pk.
Twist	MS.PV	60	5
Key	MS.PS2	65	5



Flush Mounting Enclosure IP55
with integrated PE(N) terminal

Type/ Cat. No.	Weight g/pc.	Std. Pk.
MS.F55	170	1



Indicator Light
with neon bulb, nominal rated voltage:
220 - 240V or 380 - 440V

Color	Type/ Cat. No.	Weight g/pc.	Std. Pk.
trans	MS.SLW2 MS.SLW3	10	5
green	MS.SLG2 MS.SLG3	10	5
red	MS.SLR2 MS.SLR3	10	5
yellow	MS.SLJ2 MS.SLJ3	10	5

Busbar



Busbar	for	Type/Cat. No.	for	for	for
63A	2 MS	3 MS	4 MS	5 MS	
no spacing	G45-14-2	G45-14-3	G45-14-4	G45-14-5	
with auxiliary switch (1/2 pole) spacing	G54-14-2	G54-14-3	G54-14-4	G54-14-5	

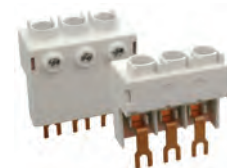

Power Feed Block

Type/ Cat. No.	Rating (A)	Std. Pk.
GE2-14	63A	1

UR Series

UL1077 Recognized Supplementary Protector

- DIN Rail Mounted
- 17.5mm width per pole
- Thermal Magnetic
- 0.5-60A / 480Y/277V AC, 50/60Hz
- 10kA Short Circuit Withstand Capacity
- Applications (on the load side of Branch Circuit Protection) include: Sensitive Electronics, Power Supplies, Appliance circuits, etc.



UR - Series	
Voltage Rating	0.5-60A / 480Y/277V AC
Short Circuit Withstand Rating	0.5 - 10A (RC): 10 kA with no back-up fuse 8 - 63A (RC): 10 kA with UL-listed Class J back-up fuse; 5 kA with no back-up fuse
Calibration Temperature	30°C (86°F)
Ambient Temperature	-25°C to +55°C (-13°F to 131°F)
Storage Temperature	-40°C to +70°C (-40°F to 158°F)
Terminal Torque (min/max)	2 Nm (17.7 lb.in.) / 2.5Nm (22.2 lb.in)
Electrical Life	6,000 switching cycles ON/ OFF
Mechanical Life	10,000 switching cycles ON/ OFF
Vibration Resistance	> 15g according to DIN EN 60069-2-59 during a load with 1.05 x I _N
Resistance to mechanical shocks	25g @ 11ms
Degree of protection acc. IEC/EN 60529	IP20
Mounting Orientation	In any plane

Short Circuit Withstand Ratings for R-Series Supplementary Protector

Trip Curve	Amp Range	Backup Protection	
		UL-Listed Class J Fuse up to 10kA	No Backup Fuse Required up to:
All	0.5 - 10A	70A	10kA
All	12 - 60A	4xRC*	5kA

*up to nearest rated current

Marking Details

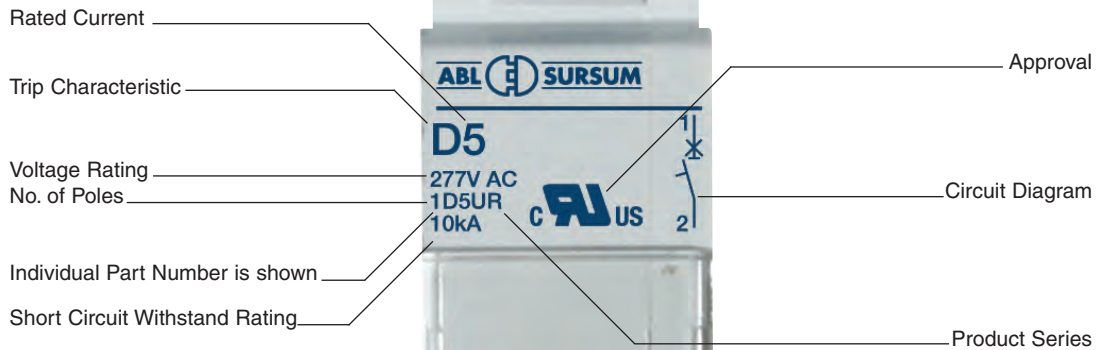

Dimensions in mm

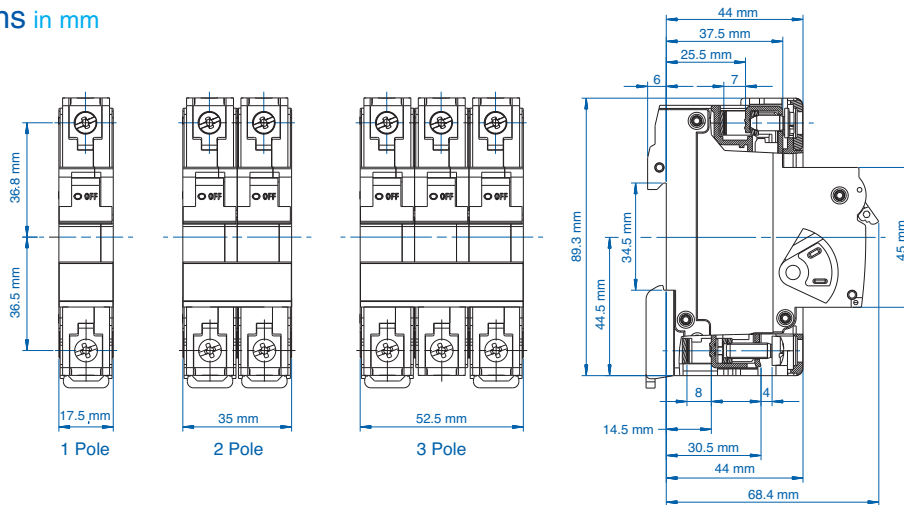

Application Overview

Trip-Characteristics*				Applications						
Characteristic Trip Boundaries				Lighting Wiring Protection Control Circuits	Business Equipment Appliances	Control Transformers	Power Supplies	General Electronics	Reactive Load	
Thermal Trip		Magnetic Trip								
Must not Trip > 100ms	Must Trip < 1hr	Must not Trip > 100ms	Must Trip at 100ms							
B-Characteristics										
1.13xRC	1.45xRC	3xRC	5xRC							
C-Characteristics										
1.13xRC	1.45xRC	5xRC	10xRC							
D-Characteristics										
1.13xRC	1.45xRC	10xRC	20xRC							

*The value of each characteristic is shown vertically beneath its corresponding heading.



Warning!

This information should only be used as a selection guide. The use of a Miniature Circuit Breaker/Supplementary Protector in an application with a certain Trip-Characteristic always requires prototype testing! It is the responsibility of the circuit design engineer to select the appropriate Miniature Circuit Breaker/Supplementary Protector for his specific application.

UL 489

UL 508

UL 1077

UL 1077
Equipment Breakers

Earth Leakage
Circuit Breakers

ANNEX

UR - Series B-Trip Characteristic

Application Examples:

Business equipment, wiring protection, lighting, appliances, control circuits, some motors and some electronic applications. Relatively long thermal trip delay but low magnetic trip point.



UL Recognized
E137915



One Pole

Rated Current	Type/ Cat. No.	Rated Voltage
0.5A	1B05UR	277V AC
1.0A	1B1UR	277V AC
2.0A	1B2UR	277V AC
3.0A	1B3UR	277V AC
4.0A	1B4UR	277V AC
5.0A	1B5UR	277V AC
6.0A	1B6UR	277V AC
8.0A	1B8UR	277V AC
10A	1B10UR	277V AC
12A	1B12UR	277V AC
13A	1B13UR	277V AC
15A	1B15UR	277V AC
16A	1B16UR	277V AC
20A	1B20UR	277V AC
25A	1B25UR	277V AC
30A	1B30UR	277V AC
32A	1B32UR	277V AC
40A	1B40UR	277V AC
50A	1B50UR	277V AC
60A	1B60UR	277V AC
63A*	1B63UR	277V AC

Standard Pack: 12

Weight:

0.3A - 32A
1.75kg (3.86 lb.)
40A - 63A
2.07kg (4.56 lb.)



Three Pole

Rated Current	Type/ Cat. No.	Rated Voltage
0.5A	3B05UR	480Y/277V AC
1.0A	3B1UR	480Y/277V AC
2.0A	3B2UR	480Y/277V AC
3.0A	3B3UR	480Y/277V AC
4.0A	3B4UR	480Y/277V AC
5.0A	3B5UR	480Y/277V AC
6.0A	3B6UR	480Y/277V AC
8.0A	3B8UR	480Y/277V AC
10A	3B10UR	480Y/277V AC
12A	3B12UR	480Y/277V AC
13A	3B13UR	480Y/277V AC
15A	3B15UR	480Y/277V AC
16A	3B16UR	480Y/277V AC
20A	3B20UR	480Y/277V AC
25A	3B25UR	480Y/277V AC
30A	3B30UR	480Y/277V AC
32A	3B32UR	480Y/277V AC
40A	3B40UR	480Y/277V AC
50A	3B50UR	480Y/277V AC
60A	3B60UR	480Y/277V AC
63A*	3B63UR	480Y/277V AC

Standard Pack: 4

Weight:

0.3A - 32A
1.75kg (3.86 lb.)
40A - 63A
2.07kg (4.56 lb.)



Two Pole

Rated Current	Type/ Cat. No.	Rated Voltage
0.5A	2B05UR	480Y/277V AC
1.0A	2B1UR	480Y/277V AC
2.0A	2B2UR	480Y/277V AC
3.0A	2B3UR	480Y/277V AC
4.0A	2B4UR	480Y/277V AC
5.0A	2B5UR	480Y/277V AC
6.0A	2B6UR	480Y/277V AC
8.0A	2B8UR	480Y/277V AC
10A	2B10UR	480Y/277V AC
12A	2B12UR	480Y/277V AC
13A	2B13UR	480Y/277V AC
15A	2B15UR	480Y/277V AC
16A	2B16UR	480Y/277V AC
20A	2B20UR	480Y/277V AC
25A	2B25UR	480Y/277V AC
30A	2B30UR	480Y/277V AC
32A	2B32UR	480Y/277V AC
40A	2B40UR	480Y/277V AC
50A	2B50UR	480Y/277V AC
60A	2B60UR	480Y/277V AC
63A*	2B63UR	480Y/277V AC

Standard Pack: 6

Weight:

0.3A - 32A
1.75kg (3.86 lb.)
40A - 63A
2.07kg (4.56 lb.)



Add-on Neutral Pole

Rated Current	Type/ Cat. No.	Rated Voltage
0.3-63A	N63UM	480/277V AC

Standard Pack: 6

Weight:

0.775kg (1.71)

Standard Dual Connection Terminal

- Box clamp terminals
Top: 18-3 AWG;
Bottom: 18-2 AWG
(Line/Load reversible)
- Ring tongue terminals

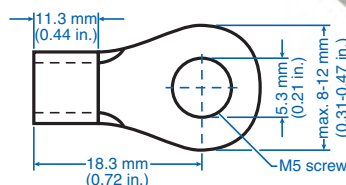
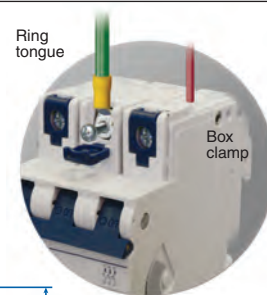

* May differ by manufacturer. Top terminal ring tongue max. thickness 1.6mm.

* 63A is not UL Recognized.

UR - Series C-Trip Characteristic

Application Examples:

Low inrush motors, lighting, wiring protection, appliances, business equipment, and control circuit applications. Relatively long thermal trip delay and medium magnetic trip point.



One Pole



Standard Pack: 12

Weight:
0.3A - 32A
1.75kg (3.86 lb.)
40A - 63A
2.07kg (4.56 lb.)

Rated Current	Type/ Cat. No.	Rated Voltage
0.5A	1C05UR	277V AC
1.0A	1C1UR	277V AC
2.0A	1C2UR	277V AC
3.0A	1C3UR	277V AC
4.0A	1C4UR	277V AC
5.0A	1C5UR	277V AC
6.0A	1C6UR	277V AC
8.0A	1C8UR	277V AC
10A	1C10UR	277V AC
12A	1C12UR	277V AC
13A	1C13UR	277V AC
15A	1C15UR	277V AC
16A	1C16UR	277V AC
20A	1C20UR	277V AC
25A	1C25UR	277V AC
30A	1C30UR	277V AC
32A	1C32UR	277V AC
40A	1C40UR	277V AC
50A	1C50UR	277V AC
60A	1C60UR	277V AC
63A*	1C63UR	277V AC

Three Pole



Standard Pack: 4

Weight:
0.3A - 32A
1.75kg (3.86 lb.)
40A - 63A
2.07kg (4.56 lb.)

Rated Current	Type/ Cat. No.	Rated Voltage
0.5A	3C05UR	480Y/277V AC
1.0A	3C1UR	480Y/277V AC
2.0A	3C2UR	480Y/277V AC
3.0A	3C3UR	480Y/277V AC
4.0A	3C4UR	480Y/277V AC
5.0A	3C5UR	480Y/277V AC
6.0A	3C6UR	480Y/277V AC
8.0A	3C8UR	480Y/277V AC
10A	3C10UR	480Y/277V AC
12A	3C12UR	480Y/277V AC
13A	3C13UR	480Y/277V AC
15A	3C15UR	480Y/277V AC
16A	3C16UR	480Y/277V AC
20A	3C20UR	480Y/277V AC
25A	3C25UR	480Y/277V AC
30A	3C30UR	480Y/277V AC
32A	3C32UR	480Y/277V AC
40A	3C40UR	480Y/277V AC
50A	3C50UR	480Y/277V AC
60A	3C60UR	480Y/277V AC
63A*	3C63UR	480Y/277V AC

Two Pole



Standard Pack: 6

Weight:
0.3A - 32A
1.75kg (3.86 lb.)
40A - 63A
2.07kg (4.56 lb.)

Rated Current	Type/ Cat. No.	Rated Voltage
0.5A	2C05UR	480Y/277V AC
1.0A	2C1UR	480Y/277V AC
2.0A	2C2UR	480Y/277V AC
3.0A	2C3UR	480Y/277V AC
4.0A	2C4UR	480Y/277V AC
5.0A	2C5UR	480Y/277V AC
6.0A	2C6UR	480Y/277V AC
8.0A	2C8UR	480Y/277V AC
10A	2C10UR	480Y/277V AC
12A	2C12UR	480Y/277V AC
13A	2C13UR	480Y/277V AC
15A	2C15UR	480Y/277V AC
16A	2C16UR	480Y/277V AC
20A	2C20UR	480Y/277V AC
25A	2C25UR	480Y/277V AC
30A	2C30UR	480Y/277V AC
32A	2C32UR	480Y/277V AC
40A	2C40UR	480Y/277V AC
50A	2C50UR	480Y/277V AC
60A	2C60UR	480Y/277V AC
63A*	2C63UR	480Y/277V AC

Add-on Neutral Pole



Rated Current	Type/ Cat. No.	Rated Voltage
0.3-63A	N63UM	480/277V AC

Standard Pack: 6

Weight:
0.775kg (1.71)

Standard Dual Connection Terminal

- Box clamp terminals
Top: 18-3 AWG;
Bottom: 18-2 AWG
(Line/Load reversible)
- Ring tongue terminals

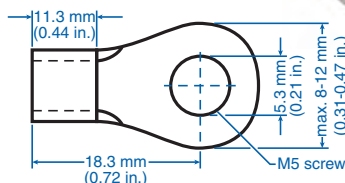
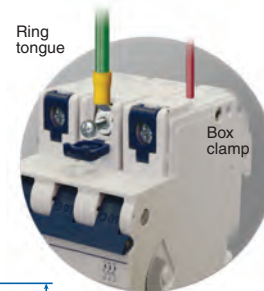

* 63A is not UL Recognized.

* May differ by manufacturer. Top terminal ring tongue max. thickness 1.6mm.

UL 489

UL 508

UL 1077

UL 1077
Equipment Breakers

Earth Leakage
Circuit Breakers

ANNEX

UR - Series

D-Trip

Characteristic

Application Examples:

Control transformers, power supplies, reactive loads. Relatively long thermal trip delay and very high magnetic trip point.



UL Recognized
E137915



Standard Pack: 12

Weight:

0.3A - 32A

1.75kg (3.86 lb.)

40A - 63A

2.07kg (4.56 lb.)

One Pole

Rated Current	Type/ Cat. No.	Rated Voltage
0.5A	1D05UR	277V AC
1.0A	1D1UR	277V AC
2.0A	1D2UR	277V AC
3.0A	1D3UR	277V AC
4.0A	1D4UR	277V AC
5.0A	1D5UR	277V AC
6.0A	1D6UR	277V AC
8.0A	1D8UR	277V AC
10A	1D10UR	277V AC
12A	1D12UR	277V AC
13A	1D13UR	277V AC
15A	1D15UR	277V AC
16A	1D16UR	277V AC
20A	1D20UR	277V AC
25A	1D25UR	277V AC
30A	1D30UR	277V AC
32A	1D32UR	277V AC
40A	1D40UR	277V AC
50A	1D50UR	277V AC
60A	1D60UR	277V AC
63A*	1D63UR	277V AC



Standard Pack: 4

Weight:

0.3A - 32A

1.75kg (3.86 lb.)

40A - 63A

2.07kg (4.56 lb.)

Three Pole

Rated Current	Type/ Cat. No.	Rated Voltage
0.5A	3D05UR	480Y/277V AC
1.0A	3D1UR	480Y/277V AC
2.0A	3D2UR	480Y/277V AC
3.0A	3D3UR	480Y/277V AC
4.0A	3D4UR	480Y/277V AC
5.0A	3D5UR	480Y/277V AC
6.0A	3D6UR	480Y/277V AC
8.0A	3D8UR	480Y/277V AC
10A	3D10UR	480Y/277V AC
12A	3D12UR	480Y/277V AC
13A	3D13UR	480Y/277V AC
15A	3D15UR	480Y/277V AC
16A	3D16UR	480Y/277V AC
20A	3D20UR	480Y/277V AC
25A	3D25UR	480Y/277V AC
30A	3D30UR	480Y/277V AC
32A	3D32UR	480Y/277V AC
40A	3D40UR	480Y/277V AC
50A	3D50UR	480Y/277V AC
60A	3D60UR	480Y/277V AC
63A*	3D63UR	480Y/277V AC



Standard Pack: 6

Weight:

0.3A - 32A

1.75kg (3.86 lb.)

40A - 63A

2.07kg (4.56 lb.)

Two Pole

Rated Current	Type/ Cat. No.	Rated Voltage
0.5A	2D05UR	480Y/277V AC
1.0A	2D1UR	480Y/277V AC
2.0A	2D2UR	480Y/277V AC
3.0A	2D3UR	480Y/277V AC
4.0A	2D4UR	480Y/277V AC
5.0A	2D5UR	480Y/277V AC
6.0A	2D6UR	480Y/277V AC
8.0A	2D8UR	480Y/277V AC
10A	2D10UR	480Y/277V AC
12A	2D12UR	480Y/277V AC
13A	2D13UR	480Y/277V AC
15A	2D15UR	480Y/277V AC
16A	2D16UR	480Y/277V AC
20A	2D20UR	480Y/277V AC
25A	2D25UR	480Y/277V AC
30A	2D30UR	480Y/277V AC
32A	2D32UR	480Y/277V AC
40A	2D40UR	480Y/277V AC
50A	2D50UR	480Y/277V AC
60A	2D60UR	480Y/277V AC
63A*	2D63UR	480Y/277V AC

*63A is not UL Recognized.



Add-on Neutral Pole

Rated Current	Type/ Cat. No.	Rated Voltage
0.3-63A	N63UM	480/277V AC

Standard Pack: 6

Weight:

0.775kg (1.71)

Standard Dual Connection Terminal

- Box clamp terminals
Top: 18-3 AWG;
Bottom: 18-2 AWG
(Line/Load reversible)
- Ring tongue terminals

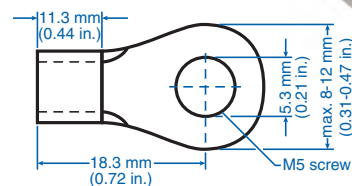
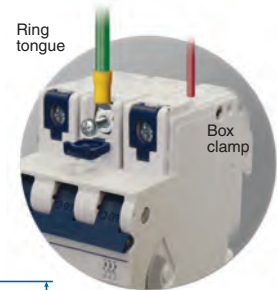

* May differ by manufacturer. Top terminal ring tongue max. thickness 1.6mm.

UR Series Accessories

For mounting instructions please refer to page 43.



Auxiliary Contact, Alarm Switch



Type/ Cat No.	Description	Contacts Type	Std Pk
H10UM	1 Auxiliary Contact	1NO	6
H11UM	2 Auxiliary Contacts	1NO + 1NC	6
H12UM	3 Auxiliary Contacts	1NO + 2NC	6
H21UM	3 Auxiliary Contacts	2NO + 1NC	6
HLS11M*	1 Auxiliary/ 1 Signal Contacts	1CO + 1CO (Signal)	6

Rated Operating Currents
10A@240V AC
3A@110V DC
1A@220V DC

Minimum Contact Load 1mA @ 24V DC
Torque max. 0.8Nm (7 lb.in)

Wire Range:
Single Wire 1.0mm² - 2.5mm² (18-14 AWG)
Stranded Wire 1.0mm² - 1.5mm² (18-16 AWG)
Stranded Wire with Ferrule 1.0mm² - 1.5mm² (18-16 AWG)

Shunt Trip



Type/ Cat No.	Rated Voltage U _N	Max. Operating Current @ U _N	Std Pk
FA12UM	12V AC/DC	1.3A	5
FA24UM	24V AC/DC	0.6A	5
FA48UM	48 - 72V AC/DC	0.2A	5
FA110UM	110 - 240 V AC/DC, 277V AC	0.25A @ 110V 0.5A @ 240V 0.58A @ 277V	5

Undervoltage Trip*



Type/ Cat No.	Line Voltage V _E	Std Pk
UA120UM	120V AC, 60Hz	5

Reset-Hold Voltage = 0.85 x V_E
Drop-Out Voltage = 0.35 ~ 0.7 x V_E
V_E = Rated Voltage

Neutral Pole

Type/ Cat No.	Rated Current I _N	Rated Voltage U _N	Std Pk
N63UM	0.3 - 63A	480Y/277V AC	6

Touch Protection Caps

to cover the terminal screw holes on the switching devices, neutral Poles and shunt trips for increased touch protection.



Type/ Cat No.	Std Pk	Type/ Cat No.	Std Pk
BS.UL	100	15.960	1

Cooling Spacer



Mounting Screw 34mm

to connect the auxiliary contact and shunt trip or neutral Pole to the circuit breaker.



Type/ Cat No.	Std Pk	Type/ Cat No.	Std Pk
E983419	10	EASS	10

Lock-out Adapter**



* Not UL approved.

** UR series can also be locked in the on and off position by simply using a common lead or meter seal, which gets fed through the hole in the handle and a corresponding hole in the housing.

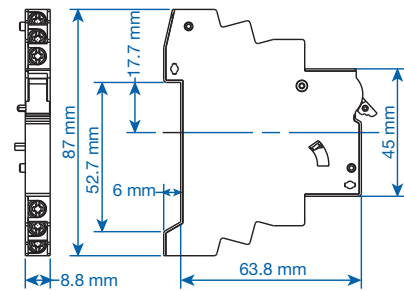

Dimensions HxxUM.

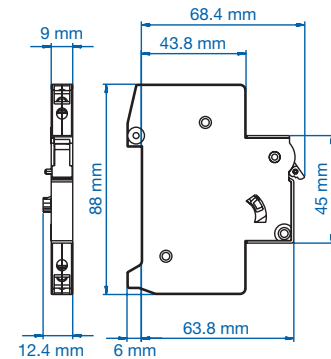

Dimensions HLS11M.

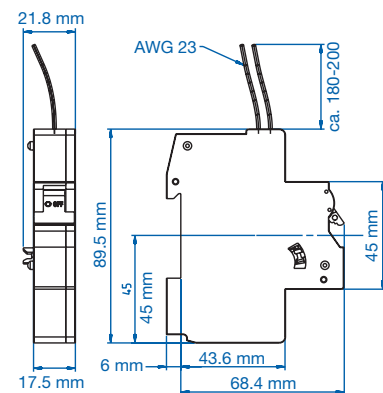

Dimensions UA120UM.

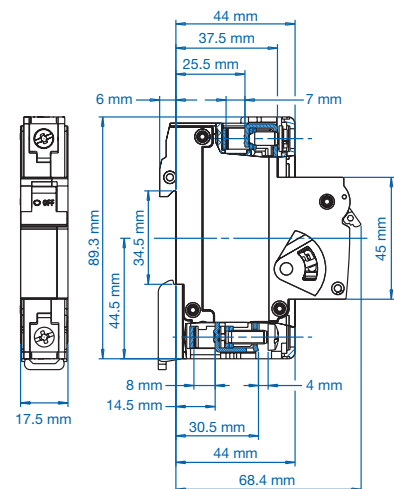

Dimensions N63UM, FAxxUM.

UL 489

UL 508

UL 1077

UL 1077
Equipment Breakers

Earth Leakage
Circuit Breakers

ANNEX

UR Series Trip Curves

B Trip Curve

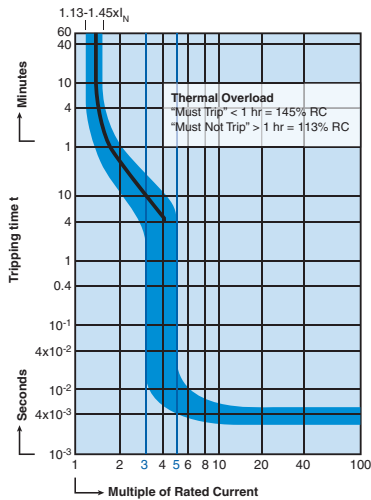

0.5A Through 10A Rated Current

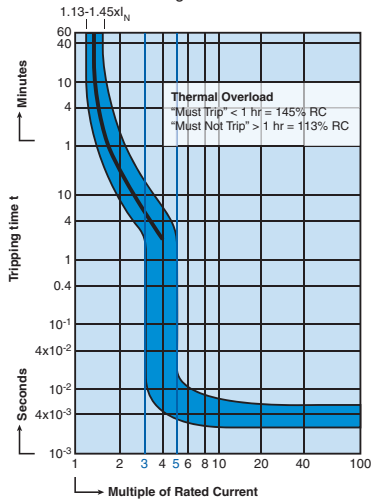

12A Through 63A Rated Current

"B" Magnetic Trip Parameters

Rated current 0.5A to 63A.

1. Hold for a minimum of 100ms at surge of 3 times rated current.
2. Trip in under 100ms at 5 times rated current.

C Trip Curve

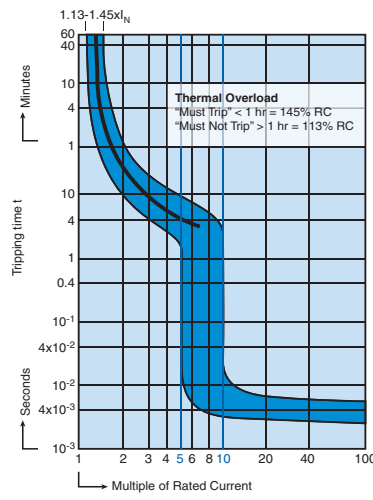

0.5A Through 10A Rated Current

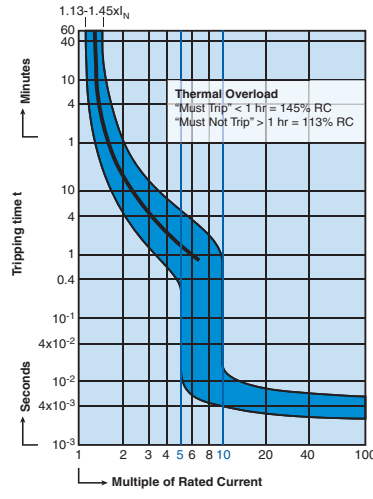

12A Through 63A Rated Current

"C" Magnetic Trip Parameters

Rated current 0.5A to 63A.

1. Hold for a minimum of 100ms at surge of 5 times rated current.
2. Trip in under 100ms at 10 times rated current.

D Trip Curve

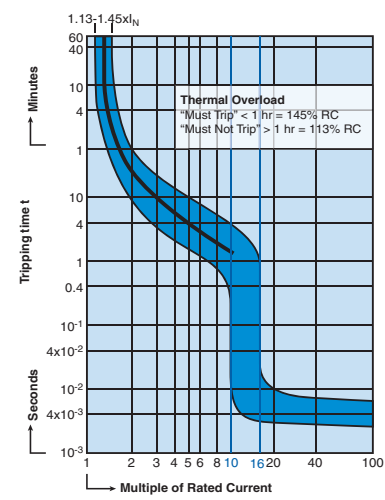

0.3A Through 10A Rated Current

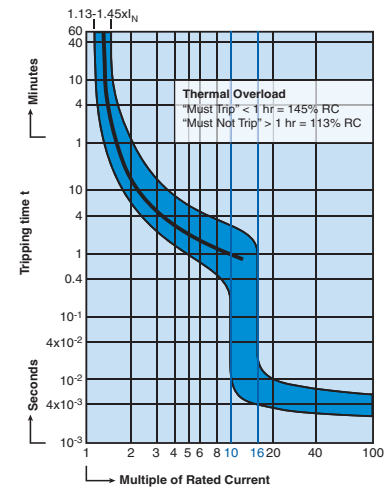

12A Through 63A Rated Current

"D" Magnetic Trip Parameters

Rated current 0.5A to 63A.

1. Hold for a minimum of 100ms at surge of 10 times rated current.
2. Trip in under 100ms at 16 times rated current.

UR Series Internal Resistance

Rated Current (A)	Trip Characteristic		
	B (Ohm)	C (Ohm)	D (Ohm)
0.5	8.0400	6.8540	6.0009
1.0	1.7000	1.7000	1.7560
2.0	0.4190	0.4190	0.4190
3.0	0.2020	0.2020	0.2020
4.0	0.1090	0.1090	0.1090
5.0	0.0654	0.0654	0.0654
6.0	0.0528	0.0528	0.0491
8.0	0.0278	0.0278	0.0240
10	0.0216	0.0216	0.0187
12/ 13	0.0113	0.0084	0.0085
15/ 16	0.0085	0.0085	0.0076
20	0.0067	0.0067	0.0064
25	0.0050	0.0050	0.0041
30/ 32	0.0032	0.0032	0.0027
40	0.0025	0.0025	0.0022
50	0.0019	0.0019	0.0018
60/ 63*	0.0018	0.0018	0.0017

Temperature Correction Curve (UL, DL, V-EA, MA and UR series)

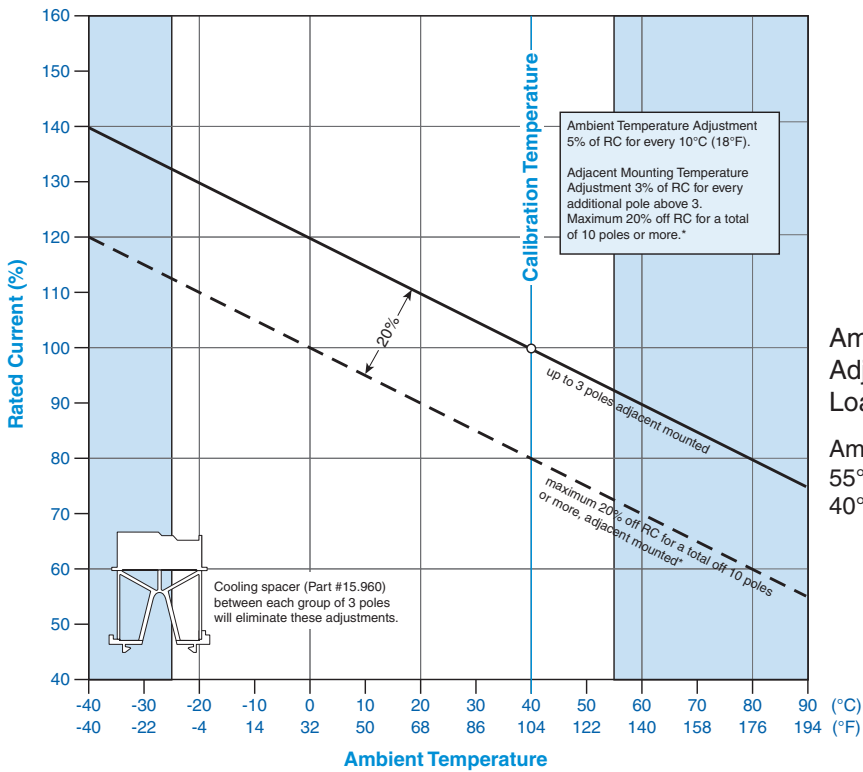

Accessory Mounting Instructions (UL, V-EA and UR series)

Neutral / Shunt Trip + Auxiliary Contact

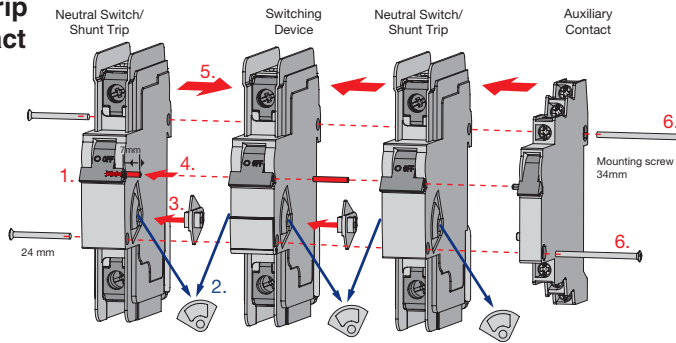

Neutral Poles N63UM, N32UL, N63UL or Shunt Trips FA..UM, FA..UL can be mounted on the right or left side of the circuit protection device.

1. Turn handle to off position.
2. Remove gray cover from the circuit protection device and accessory.
3. Insert linkage component between circuit protection device and neutral pole (N63UM, N32UL, N63UL) or shunt trip (FA..UM, FA..UL).
4. Insert connecting pin into handle.
5. Assemble circuit protection device and neutral pole (N63UM, N32UL, N63UL) or shunt trip (FA..UM, FL..UL).
6. The auxiliary contact (H..UM, H..UL) can also be mounted on the right side by using a different screw (E983419; see accessory pages 14, 32 or 41).

After final assembly check operation by moving the handle to the ON/OFF position several times.

Auxiliary Contact

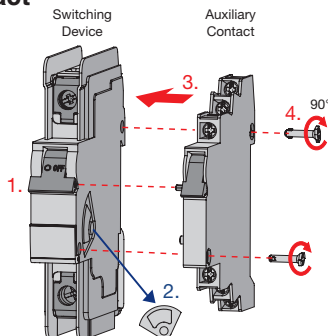

Auxiliary contact can be mounted on the right side of the circuit protection device only.

1. Turn handles to OFF position.
2. Remove gray cover from switching device.
3. Combine circuit protection device and auxiliary contact (H...UM, H...UL).
4. Insert mounting screws and connect the two devices by turning the screws 90° clockwise.

After final assembly check operation by moving the handle to the ON/OFF position several times.

UL 489

UL 508

UL 1077

UL 1077
Equipment Breakers

Earth Leakage
Circuit Breakers

ANNEX

R-Series

UL1077 Recognized Supplementary Protector

- DIN Rail Mounted
- 17.5mm width per pole
- Thermal Magnetic
- 480Y/277V AC, 50/60Hz
- 10kA Short Circuit Withstand Capacity
- Positive Trip indicator (Green - off/tripped, Red - on)
- Applications (on the load side of Branch Circuit Protection) include: Sensitive Electronics, Power Supplies, Appliance circuits, etc.

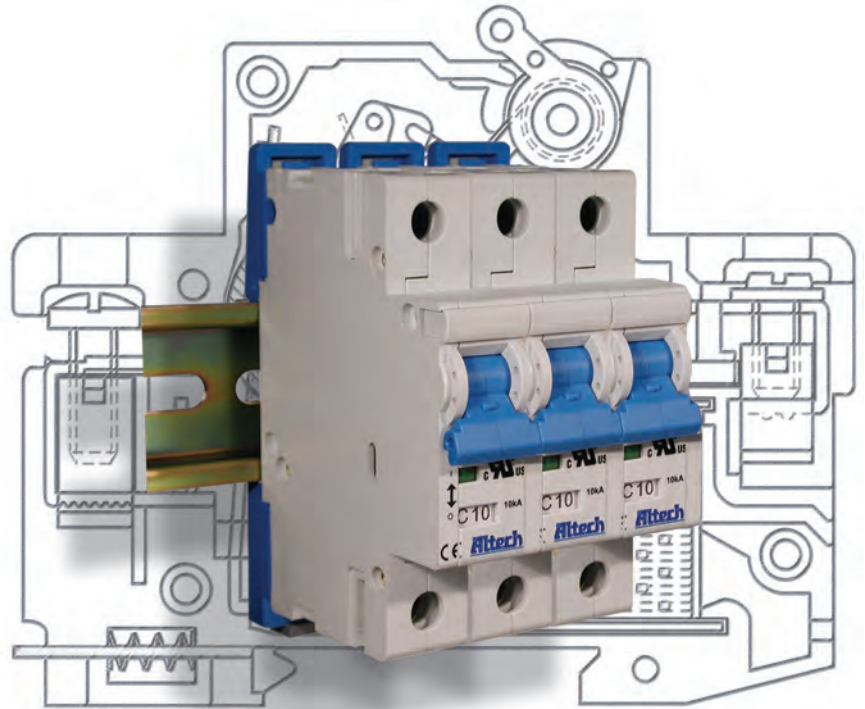



 E301611

Voltage Rating	480Y/277VAC
Short Circuit Withstand Rating (UL - Ratings)	0.5-6A (RC): 10kA with no back-up fuse 8-63A (RC): 10kA with UL-listed Class J back-up fuse; 5kA with no back-up fuse
Interrupting Capacity (IEC/EN60898/60947-2)	0.5-63A (RC): 10kA
Calibration Temperature	30°C (86°F)
Operating Temperature	-25° to 60°C (-13° to 140°F)
Storage Temperature	-25° to 75°C (-13° to 167°F)
Terminal Size Acceptability and Torque	14-3 AWG: 17.5 lb-in. (2.0 Nm) 18-16 AWG: 25 lb-in. (2.8 Nm)
Terminal Protection Degree	IP20 at front
Electrical Life	6,000 cycles on/off
Mechanical Life	10,000 cycles on/off
Wire Connection	copper wire only 60/75°C
Vibration Resistance	3g (18-50Hz)
Mounting Orientation	In any plane

Indicator window



 ON
 OFF

Trip curve and amperage window display.

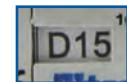

SHORT CIRCUIT WITHSTAND RATINGS FOR R-SERIES SUPPLEMENTARY PROTECTOR

Trip Curve	Amp Range	Backup Protection	
		UL-Listed Class J Fuse up to 10kA	No Backup Fuse Required up to:
All	0.5 - 6A	4xRC*	10kA
All	8 - 63A	4xRC*	5kA

*up to nearest rated current

DC voltage rating: 48 VDC (self-certified).

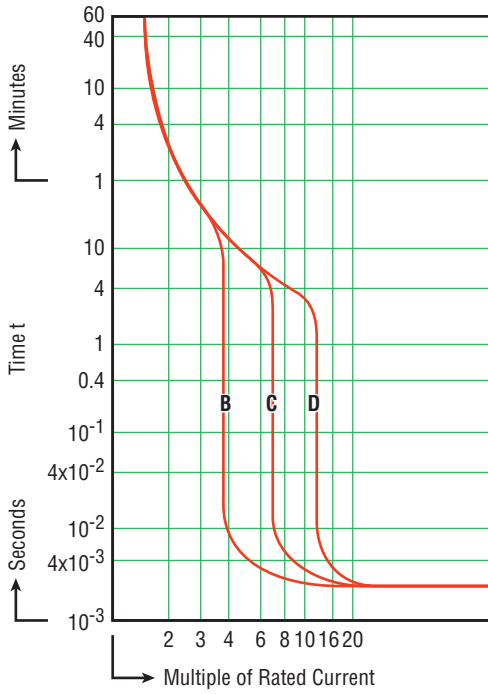

Time versus Current Trip Curve

For the exact trip curve, please refer to page 67.

Dimensions in mm side view

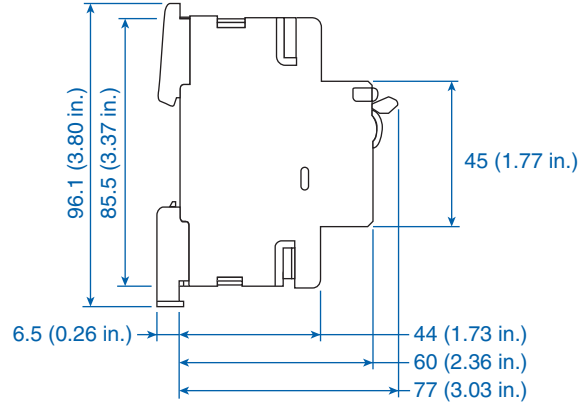

1 POLE

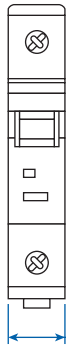

2 POLE

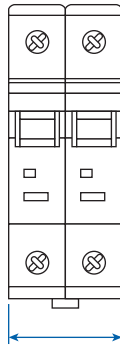

3 POLE

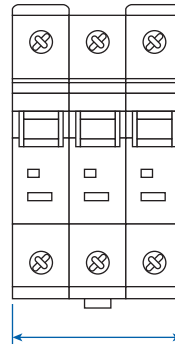

Trip-Characteristics*				Applications					
Characteristic Trip Boundaries				Lighting Wiring Protection Control Circuits	Business Equipment Appliances	Control Transformers	Power Supplies	General Electronics	Reactive Load
Thermal Trip		Magnetic Trip							
Must not Trip > 100ms	Must Trip < 1hr	Must not Trip > 100ms	Must Trip at 100ms						
B-Characteristics				1.13xRC	1.45xRC	3xRC	5xRC	1.13xRC	1.45xRC
C-Characteristics									
D-Characteristics				1.13xRC	1.45xRC	10xRC	20xRC	1.13xRC	1.45xRC

*The value of each characteristic is shown vertically beneath its corresponding heading.



Warning!

This information should only be used as a selection guide. The use of a Miniature Circuit Breaker/Supplementary Protector in an application with a certain Trip-Characteristic always requires prototype testing! It is the responsibility of the circuit design engineer to select the appropriate Miniature Circuit Breaker/Supplementary Protector for his specific application.

UL 489

UL 508

UL 1077

UL 1077
Equipment Breakers

Earth Leakage
Circuit Breakers

ANNEX

B-Trip Characteristic

Application Examples:

Business equipment, wiring protection, lighting, appliances, control circuits and some electronic applications. Relatively long thermal trip delay but low magnetic trip point.



E301611



One Pole

Rated Current	Type/ Cat. No.
0.5A	1BU05R
1.0A	1BU1R
2.0A	1BU2R
3.0A	1BU3R
4.0A	1BU4R
5.0A	1BU5R
6.0A	1BU6R
8.0A	1BU8R
10A	1BU10R
12A	1BU12R
13A	1BU13R
15A	1BU15R
16A	1BU16R
20A	1BU20R
25A	1BU25R
30A	1BU30R
32A	1BU32R
40A	1BU40R
50A	1BU50R
60A	1BU60R
63A	1BU63R

Standard Pack: 12

Weight:

0.5A - 63A: 1.6kg (3.54 lb.)



Two Pole

Rated Current	Type/ Cat. No.
0.5A	2BU05R
1.0A	2BU1R
2.0A	2BU2R
3.0A	2BU3R
4.0A	2BU4R
5.0A	2BU5R
6.0A	2BU6R
8.0A	2BU8R
10A	2BU10R
12A	2BU12R
13A	2BU13R
15A	2BU15R
16A	2BU16R
20A	2BU20R
25A	2BU25R
30A	2BU30R
32A	2BU32R
40A	2BU40R
50A	2BU50R
60A	2BU60R
63A	2BU63R

Standard Pack: 6

Weight:

0.5A - 63A: 1.6kg (3.54 lb.)



Three Pole

Rated Current	Type/ Cat. No.
0.5A	3BU05R
1.0A	3BU1R
2.0A	3BU2R
3.0A	3BU3R
4.0A	3BU4R
5.0A	3BU5R
6.0A	3BU6R
8.0A	3BU8R
10A	3BU10R
12A	3BU12R
13A	3BU13R
15A	3BU15R
16A	3BU16R
20A	3BU20R
25A	3BU25R
30A	3BU30R
32A	3BU32R
40A	3BU40R
50A	3BU50R
60A	3BU60R
63A	3BU63R

Standard Pack: 4

Weight:

0.5A - 63A: 1.66kg (3.67 lb.)



Four Pole
Please contact
Altech.

Non-standard current ratings available. Minimum quantities may apply. Please contact Altech for further details.

C-Trip Characteristic

Application Examples:
Lighting, wiring protection, appliances, business equipment, and control circuit applications. Relatively long thermal trip delay and medium magnetic trip point.



One Pole

Rated Current	Type/ Cat. No.
0.5A	1CU05R
1.0A	1CU1R
2.0A	1CU2R
3.0A	1CU3R
4.0A	1CU4R
5.0A	1CU5R
6.0A	1CU6R
8.0A	1CU8R
10A	1CU10R
12A	1CU12R
13A	1CU13R
15A	1CU15R
16A	1CU16R
20A	1CU20R
25A	1CU25R
30A	1CU30R
32A	1CU32R
40A	1CU40R
50A	1CU50R
60A	1CU60R
63A	1CU63R

Standard Pack: 12

Weight:
0.5A - 63A: 1.6kg (3.54 lb.)



Two Pole

Rated Current	Type/ Cat. No.
0.5A	2CU05R
1.0A	2CU1R
2.0A	2CU2R
3.0A	2CU3R
4.0A	2CU4R
5.0A	2CU5R
6.0A	2CU6R
8.0A	2CU8R
10A	2CU10R
12A	2CU12R
13A	2CU13R
15A	2CU15R
16A	2CU16R
20A	2CU20R
25A	2CU25R
30A	2CU30R
32A	2CU32R
40A	2CU40R
50A	2CU50R
60A	2CU60R
63A	2CU63R

Standard Pack: 6

Weight:
0.5A - 63A: 1.6kg (3.54 lb.)



Three Pole

Rated Current	Type/ Cat. No.
0.5A	3CU05R
1.0A	3CU1R
2.0A	3CU2R
3.0A	3CU3R
4.0A	3CU4R
5.0A	3CU5R
6.0A	3CU6R
8.0A	3CU8R
10A	3CU10R
12A	3CU12R
13A	3CU13R
15A	3CU15R
16A	3CU16R
20A	3CU20R
25A	3CU25R
30A	3CU30R
32A	3CU32R
40A	3CU40R
50A	3CU50R
60A	3CU60R
63A	3CU63R

Standard Pack: 4

Weight:
0.5A - 63A: 1.66kg (3.67 lb.)



Four Pole
Please contact
Altech.

Non-standard current ratings available. Minimum quantities may apply. Please contact Altech for further details.

D-Trip Characteristic



E301611

Application Examples:

Control transformers, power supplies and reactive loads. Relatively long thermal trip delay and very high magnetic trip point.



One Pole

Rated Current	Type/ Cat. No.
0.5A	1DU05R
1.0A	1DU1R
2.0A	1DU2R
3.0A	1DU3R
4.0A	1DU4R
5.0A	1DU5R
6.0A	1DU6R
8.0A	1DU8R
10A	1DU10R
12A	1DU12R
13A	1DU13R
15A	1DU15R
16A	1DU16R
20A	1DU20R
25A	1DU25R
30A	1DU30R
32A	1DU32R
40A	1DU40R
50A	1DU50R
60A	1DU60R
63A	1DU63R

Standard Pack: 12

Weight:
0.5A - 63A: 1.6kg (3.54 lb.)



Two Pole

Rated Current	Type/ Cat. No.
0.5A	2DU05R
1.0A	2DU1R
2.0A	2DU2R
3.0A	2DU3R
4.0A	2DU4R
5.0A	2DU5R
6.0A	2DU6R
8.0A	2DU8R
10A	2DU10R
12A	2DU12R
13A	2DU13R
15A	2DU15R
16A	2DU16R
20A	2DU20R
25A	2DU25R
30A	2DU30R
32A	2DU32R
40A	2DU40R
50A	2DU50R
60A	2DU60R
63A	2DU63R

Standard Pack: 6

Weight:
0.5A - 63A: 1.6kg (3.54 lb.)



Three Pole

Rated Current	Type/ Cat. No.
0.5A	3DU05R
1.0A	3DU1R
2.0A	3DU2R
3.0A	3DU3R
4.0A	3DU4R
5.0A	3DU5R
6.0A	3DU6R
8.0A	3DU8R
10A	3DU10R
12A	3DU12R
13A	3DU13R
15A	3DU15R
16A	3DU16R
20A	3DU20R
25A	3DU25R
30A	3DU30R
32A	3DU32R
40A	3DU40R
50A	3DU50R
60A	3DU60R
63A	3DU63R

Standard Pack: 4

Weight:
0.5A - 63A: 1.66kg (3.67 lb.)

Four Pole
Please contact
Altech.

Non-standard current ratings available. Minimum quantities may apply. Please contact Altech for further details.

R-Series Trip Curves

B, C and D Trip
Less than 10A

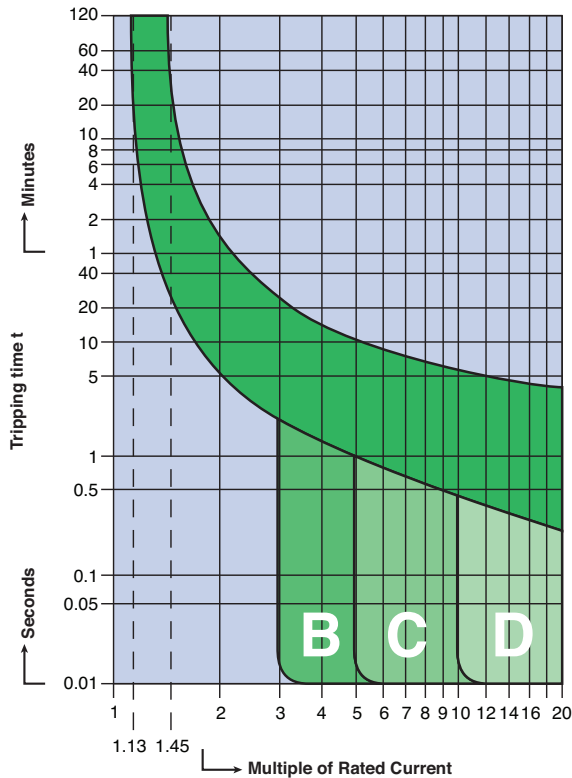

B, C and D Trip
10A and higher

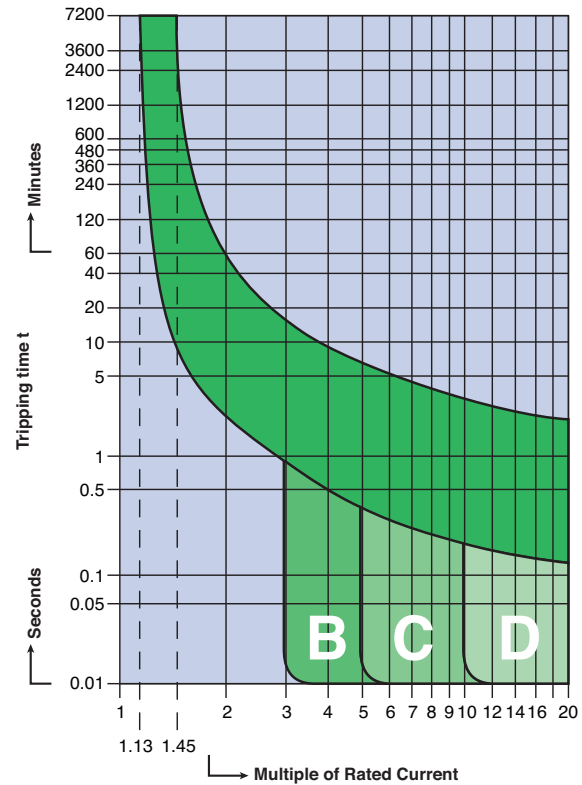

Temperature and Power Loss Specifications

Rated current of MCB	Internal Impedances & Power Loss					MCB Temperature Compensation								
	Internal impedance	Power loss on CB	Maximum allowable impedance of breakdown loop (0.2/0.4s)			Effective rated current allowing for ambient temperature.								
			Z (m Ω)	P (W)	Z _s (Ω)			I _{cor} (A)						
I _n (A)	Char. B,C,D	Char. B,C,D	Char.B	Char.C	Char.D	Ambient Temperature								
						-20°C	-10°C	0°C	10°C	20°C	30°C	40°C	50°C	60°C
0.50	6600	1.7	42.0	51.1	28.8	0.61	0.59	0.57	0.55	0.53	0.50	0.47	0.44	0.42
1.00	1650	1.7	46.0	25.6	14.4	1.21	1.18	1.14	1.10	1.05	1.00	0.93	0.88	0.83
2.00	370	1.5	23.0	12.8	7.2	2.42	2.36	2.28	2.20	2.10	2.00	1.86	1.76	1.67
3.00	210	1.9	15.3	8.5	4.8	3.63	3.54	3.42	3.30	3.15	3.00	2.79	2.64	2.50
4.00	126	2.0	11.5	6.4	3.6	4.84	4.72	4.56	4.40	4.20	4.00	3.72	3.52	3.33
6.00	51	1.8	7.7	4.3	2.4	7.30	7.10	6.80	6.60	6.30	6.00	5.60	5.30	5.00
8.00	21	1.3	5.8	3.2	1.8	9.70	9.40	9.10	8.80	8.40	8.00	7.40	7.00	6.70
10.00	14.8	1.5	4.6	2.6	1.4	12.1	11.8	11.40	11.00	10.50	10.00	9.30	8.80	8.30
13.00	11.3	1.9	3.5	2.0	1.1	15.7	15.3	14.80	14.30	13.70	13.00	12.10	11.50	10.80
16.00	7.5	1.9	2.9	1.6	0.9	19.4	18.9	18.20	17.60	16.80	16.00	14.90	14.10	13.30
20.00	6.3	2.5	2.3	1.3	0.7	24.2	23.60	22.80	22.00	21.00	20.00	18.60	17.60	16.70
25.00	4.4	2.8	1.8	1.0	0.6	30.3	29.50	28.50	27.50	26.30	25.00	23.30	22.00	20.80
32.00	3.1	3.2	1.4	0.8	0.4	38.7	37.80	36.50	35.20	33.60	32.00	29.80	28.20	26.70
40.00	2.5	4.0	1.2	0.6	0.4	48.4	47.20	45.60	44.00	42.00	40.00	37.20	35.20	33.30
50.00	2.2	5.5	0.9	0.5	0.3	60.5	59.0	57.00	55.00	52.50	50.00	46.50	44.10	41.70
63.00	1.6	6.4	0.7	0.4	0.2	76.2	74.30	71.80	69.30	66.20	63.00	58.60	55.50	52.50

UL 489

UL 508

UL 1077

UL 1077
Equipment Breakers

Earth Leakage
Circuit Breakers

ANNEX

Accessories

R-Series Supplementary Protector



Accessories can be factory or field mounted on R-Series supplementary protectors for enhanced control and monitoring capabilities. Field mounting kits include all necessary parts and instructions. Accessories can be gang mounted on a single controller (the Auxiliary Switch in the outside position). The mounting arrangement links the internal latch-pins for the tripping mechanisms, ensuring simultaneous trips. Handles are linked to simplify manual resetting.



Neutral Pole (63A/480Y/277 VAC)

Description	Type/ Cat. No.	Cable Max	Cable Min	Torque Max	Torque Min
Neutral	ALTN2	25mm ² AWG 3	2.5mm ² AWG 12	2Nm 17.5 lb-in	1.5Nm 12 lb-in

Standard Pack: 10

Weight: 1.25kg (2.77 lb.)



Shunt Trip

Shunt Trip and Undervoltage Trip

Description	Shunt Trip Type/Cat. No.	Operational Voltage	Rated Coil Current	Undervoltage Trip* Type/Cat. No.
AC Coil:				
12V AC	FA12ACR	8.4 - 13.2V	6A	UV12ACR
24V AC	FA24ACR	16.8 - 26.4V	2.8A	UV24ACR
48V AC	FA48ACR	33.6 - 52.8V	0.8A	UV48ACR
60V AC	FA60ACR	42 - 66V	~0.7A	UV60ACR
110V AC	FA110ACR	77 - 121V	0.5A	UV110ACR
120V AC	FA120ACR	84 - 132V	~0.5A	UV120ACR
230V AC	FA230ACR	161 - 253V	0.6A	UV230ACR
277V AC	FA277ACR	194 - 305V	~0.5A	UV277ACR
400V AC	FA400ACR	280 - 440V	0.5A	UV400ACR
DC Coil:				
12V DC	FA12DCR	8.4 - 13.2V	~6A	UV12DCR
24V DC	FA24DCR	16.8 - 26.4V	3A	UV24DCR
48V DC	FA48DCR	33.6 - 52.8V	2A	UV48DCR
110V DC	FA110DCR	77 - 121V	0.6A	UV110DCR

* Reset-Hold Voltage = $0.85 \times V_E$; Drop-Out Voltage = $0.2 \times V_E$

Standard Pack: 10

Weight: 1.1kg (2.43 lb.)



Undervoltage Trip

Terminal Size - min/max	2.5 mm ² (12 AWG) / 25mm ² (3 AWG)
Terminal Torque - min/max	1.5 Nm (12 lb. in.) / 2 Nm (17.5 lb. in.)



Auxiliary Contact (4A/230 VAC)

Description	Type/ Cat. No.	Cable Max	Cable Min	Torque Max	Torque Min
1 x CO	H1COR	2.5mm ² AWG 12	0.5mm ² AWG 20	0.5Nm 4 lb-in	0.33Nm 3 lb-in
2 x CO	H2COR				
1 x CO, 1 Signal & Test Button	HSTCOR				

Standard Pack: 15

Weight: H1COR: 0.5kg (1.32 lb.); H2COR, HSTCOR: 0.72kg (1.59 lb.)

Wiring Diagram

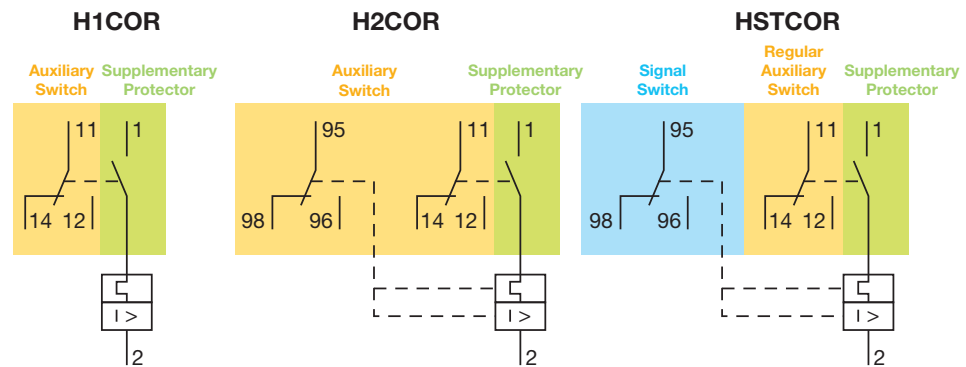

Lock-out Adapter

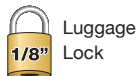

Description	Type/ Cat. No.
Yellow	EASS2

Standard Pack: 10

Weight: 50g (1.76 oz.)

UL 489

UL 508

UL 1077

UL 1077
Equipment Breakers

Earth Leakage
Circuit Breakers

ANNEX

Altech UL1077/508 Busbar System



UL1077/508 Listed Busbars

The Altech Busbar System is an innovative way to jumper up to 57 poles of Manual Motor Controllers (MMC) and Supplementary Protectors (SP).

The advantages of this busbar system are:

- 30% Installation time savings
- Panel space savings
- Reduced maintenance
- High electrical ratings

UL1077/508 Busbar System

- 1-57 different pin configurations
- 1/2 pole spacing (auxiliary switch) available
- Power Feeding:
Power Feed Lugs (115A), Direct Power Feed (115A), Power Feed Block (200A)
- UL recognized and listed for Altech's R-Series, ABL's UR, V-EA and MA Series of Manual Motor Controllers and Supplementary Protectors
- UL recognized and listed for use with most popular UL1077 supplementary protectors and UL508 Manual Motor Controllers in the market.
- Customers can cut the Busbar without losing the UL approval
- Line/Load reversible

Technical Specifications

Material of Busbar

Busbars UL1077/ 508

Copper

Material of Insulation (Housing)

Polyamide

Electrical Ratings

18mm²: 80A/600V AC/DC*

25mm²: 100A/600V AC/DC*

Short Circuit Withstand Rating

10kA

Applying Standards

UL508, VDE0660 Part 100 and 502,

VDE 0606, VDE 0659

Without Altech Busbar System

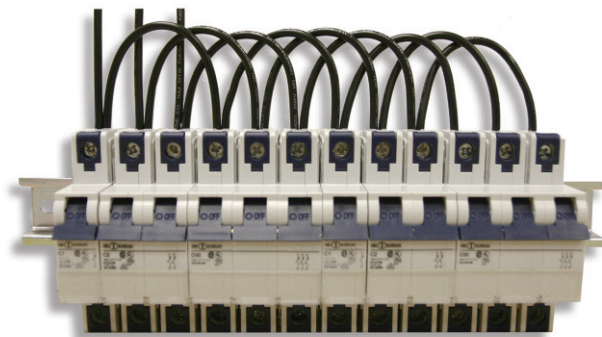

With Altech Busbar System

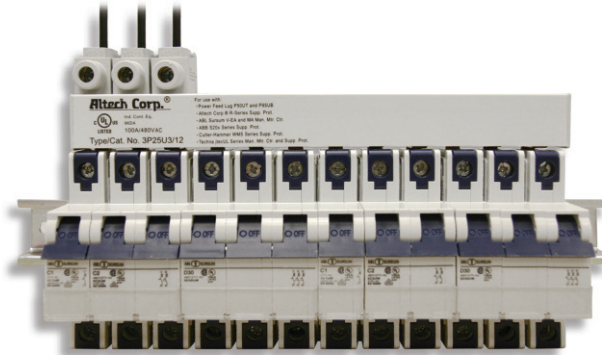

Universal UL1077/508 Busbar fits most Supplementary Protectors and Manual Motor Controllers in the market!

Please contact Altech for details and further information.

* 1000VDC ratings can be achieved by using all poles at the same voltage and polarity.

Altech UL1077/508 Busbar System

Power Feed Methods

1) Start/ End Feed Method

P50UT* / P50UB*

With the **P50UT** Power Feed Lug or the **P50UB** Modular Direct Power Feed as a Start/End Feeding Device a maximum input current of **80A/100A per Phase** can be achieved. 80A with 18mm² Busbar and 100A with 25mm² Busbar.

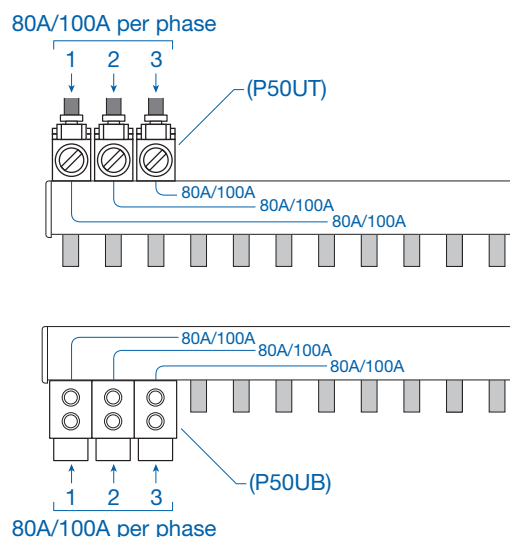

2) Center/ Middle Feed Method

P50UT* / P50UB*

With the **P50UT** Power Feed Lug or the **P50UB** Modular Direct Power Feed as a Center/Middle Feeding Device a maximum input current of **115A per Phase** can be achieved. (18mm²: 80A + 35A; 25mm²: 100A + 15A)

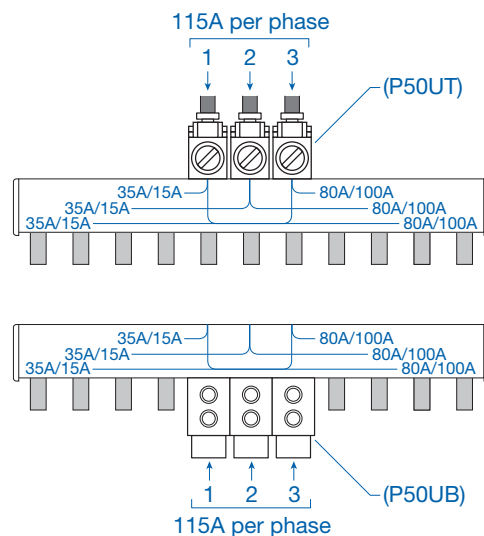

P95UB*

With the **P95UB** Power Feed Block as a Center/Middle Feeding Device a maximum input current of **160A/200A per Phase** can be achieved (160A with 18mm² Busbar and 200A with 25mm² Busbar).

Note: The Power Feed Block can only be used with a standard spacing **3 Phase** UL1077/508 Busbar.

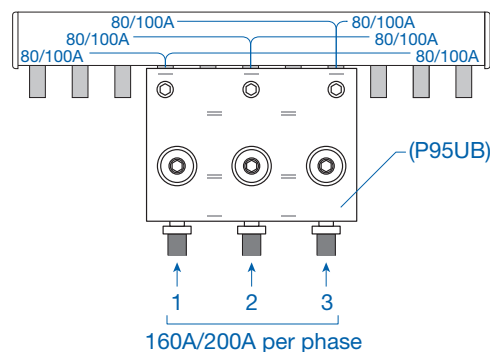

* For complete specifications and description of Feeding Devices see page 78-79.

1 PHASE BUSBAR - standard spacing

18mm² for 80A

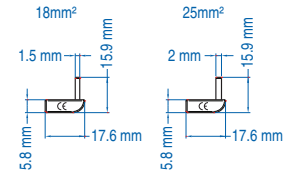
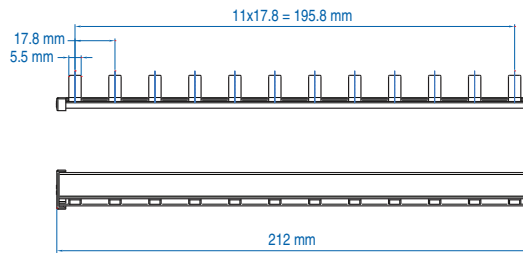

shown: 1P18U1/12

18mm² for 80A*

Type/ Cat. No.	No. of Pins	Length [mm]
1P18U1/2	2	32
1P18U1/3	3	54
1P18U1/4	4	79
1P18U1/5	5	88
1P18U1/6	6	106
1P18U1/7	7	122
1P18U1/8	8	140
1P18U1/9	9	158
1P18U1/10	10	177
1P18U1/11	11	195
1P18U1/12	12	212
1P18U1/13	13	230
1P18U1/14	14	248
1P18U1/15	15	269
1P18U1/16	16	286
1P18U1/17	17	304
1P18U1/18	18	322
1P18U1/19	19	340
1P18U1/20	20	354
1P18U1/21	21	374
1P18U1/22	22	392
1P18U1/23	23	410
1P18U1/24	24	428
1P18U1/25	25	446
1P18U1/26	26	464
1P18U1/27	27	482
1P18U1/28	28	500
1P18U1/29	29	518

18mm² for 80A*

Type/ Cat. No.	No. of Pins	Length [mm]
1P18U1/30	30	536
1P18U1/31	31	554
1P18U1/32	32	572
1P18U1/33	33	590
1P18U1/34	34	608
1P18U1/35	35	626
1P18U1/36	36	638
1P18U1/37	37	656
1P18U1/38	38	674
1P18U1/39	39	692
1P18U1/40	40	710
1P18U1/41	41	728
1P18U1/42	42	746
1P18U1/43	43	764
1P18U1/44	44	782
1P18U1/45	45	800
1P18U1/46	46	818
1P18U1/47	47	836
1P18U1/48	48	854
1P18U1/49	49	872
1P18U1/50	50	890
1P18U1/51	51	908
1P18U1/52	52	926
1P18U1/53	53	942
1P18U1/54	54	960
1P18U1/55	55	978
1P18U1/56	56	996
1P18U1/57	57	1014

ACCESSORIES



Type/Cat. No: **P50UT-LP**
Description: Power Feed Lug



Type/Cat. No: **P50UB**
Description: Modular Direct Power Feed



Type/Cat. No: **BRB5W**
Description: Insulation Cap



Type/Cat. No: **18/25CAP1P**
Description: End Cap

* 25mm² version for 100A available upon request.

1 PHASE BUSBAR - 1/2 pole spacing

18mm² for 80A

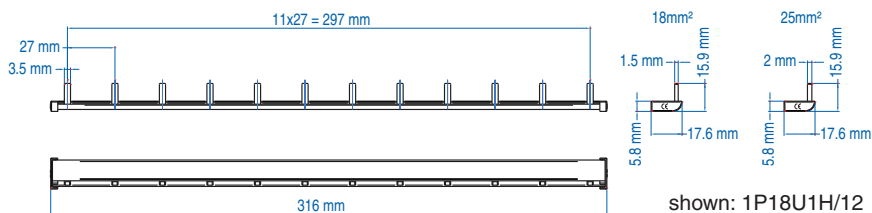
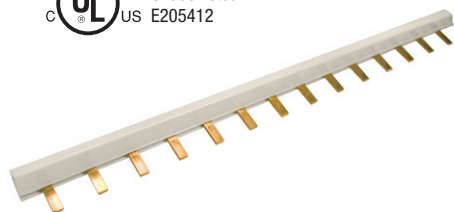

shown: 1P18U1H/12

18mm² for 80A*

Type/ Cat. No.	No. of Pins	Length [mm]
1P18U1H/2	2	40
1P18U1H/3	3	68
1P18U1H/4	4	95
1P18U1H/5	5	122
1P18U1H/6	6	150
1P18U1H/7	7	176
1P18U1H/8	8	204
1P18U1H/9	9	230
1P18U1H/10	10	258
1P18U1H/11	11	284
1P18U1H/12	12	316
1P18U1H/13	13	338
1P18U1H/14	14	365
1P18U1H/15	15	392
1P18U1H/16	16	420
1P18U1H/17	17	446
1P18U1H/18	18	474
1P18U1H/19	19	500

18mm² for 80A*

Type/ Cat. No.	No. of Pins	Length [mm]
1P18U1H/20	20	528
1P18U1H/21	21	554
1P18U1H/22	22	582
1P18U1H/23	23	608
1P18U1H/24	24	635
1P18U1H/25	25	662
1P18U1H/26	26	690
1P18U1H/27	27	716
1P18U1H/28	28	744
1P18U1H/29	29	770
1P18U1H/30	30	798
1P18U1H/31	31	824
1P18U1H/32	32	852
1P18U1H/33	33	878
1P18U1H/34	34	905
1P18U1H/35	35	932
1P18U1H/36	36	960

UL 489

UL 508

UL 1077

UL 1077
Equipment Breakers

Earth Leakage
Circuit Breakers

ANNEX

ACCESSORIES



Type/Cat. No: **P50UT-LP**
Description: Power Feed Lug



Type/Cat. No: **P50UB**
Description: Modular Direct Power Feed



Type/Cat. No: **BRB5W**
Description: Insulation Cap



Type/Cat. No: **18/25CAP1P**
Description: End Cap

* 25mm² version for 100A available upon request.

2 PHASE BUSBAR - standard spacing

18mm² for 80A / 25mm² for 100A

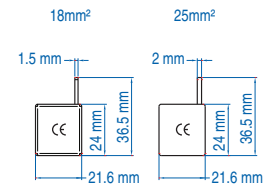
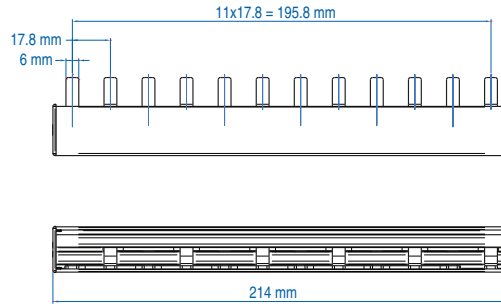

shown: 2P18U3/12

18mm² for 80A

25mm² for 100A

Type/ Cat. No.	No. of Pins	Length [mm]	Type/ Cat. No.	No. of Pins	Length [mm]
2P18U3/4	4	69	2P25U3/4	4	69
2P18U3/6	6	104	2P25U3/6	6	104
2P18U3/8	8	140	2P25U3/8	8	140
2P18U3/10	10	177	2P25U3/10	10	177
2P18U3/12	12	214	2P25U3/12	12	214
2P18U3/14	14	249	2P25U3/14	14	249
2P18U3/16	16	283	2P25U3/16	16	283
2P18U3/18	18	319	2P25U3/18	18	319
2P18U3/20	20	357	2P25U3/20	20	357
2P18U3/22	22	390	2P25U3/22	22	390
2P18U3/24	24	426	2P25U3/24	24	426
2P18U3/26	26	460	2P25U3/26	26	460
2P18U3/28	28	498	2P25U3/28	28	498
2P18U3/30	30	532	2P25U3/30	30	532
2P18U3/32	32	568	2P25U3/32	32	568
2P18U3/34	34	604	2P25U3/34	34	604
2P18U3/36	36	640	2P25U3/36	36	640
2P18U3/38	38	675	2P25U3/38	38	675
2P18U3/40	40	710	2P25U3/40	40	710
2P18U3/42	42	746	2P25U3/42	42	746
2P18U3/44	44	782	2P25U3/44	44	782
2P18U3/46	46	818	2P25U3/46	46	818
2P18U3/48	48	854	2P25U3/48	48	854
2P18U3/50	50	888	2P25U3/50	50	888
2P18U3/52	52	924	2P25U3/52	52	924
2P18U3/54	54	960	2P25U3/54	54	960
2P18U3/56	56	994	2P25U3/56	56	994

ACCESSORIES

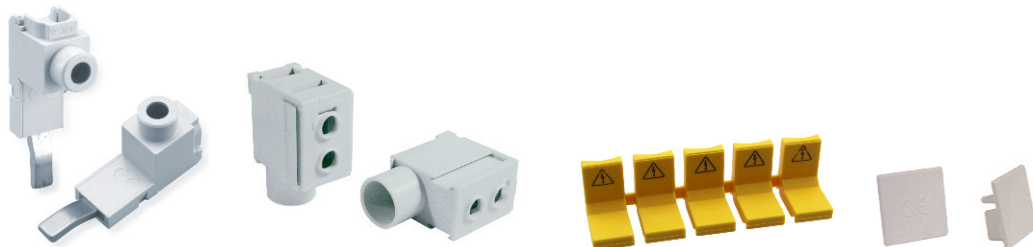

Type/Cat. No:	P50UT	P50UB	BRB5W	18/25CAP3P
Description:	Power Feed Lug	Modular Direct Power Feed	Insulation Cap	End Cap

2 PHASE BUSBAR - 1/2 pole spacing

18mm² for 80A / 25mm² for 100A

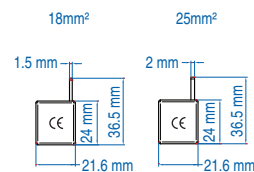
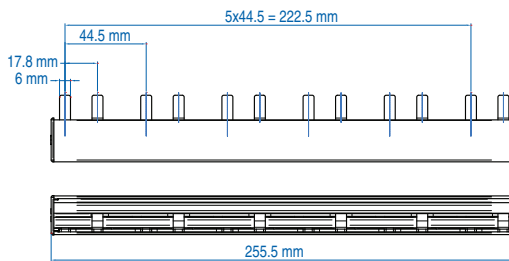

shown: 2P18U3H/12

UL 489

UL 508

UL 1077

UL 1077
Equipment Breakers

Earth Leakage
Circuit Breakers

ANNEX

18mm² for 80A

25mm² for 100A

Type/ Cat. No.	No. of Pins	Length [mm]	Type/ Cat. No.	No. of Pins	Length [mm]
2P18U3H/4	4	78	2P25U3H/4	4	78
2P18U3H/6	6	124	2P25U3H/6	6	124
2P18U3H/8	8	168	2P25U3H/8	8	168
2P18U3H/10	10	212	2P25U3H/10	10	212
2P18U3H/12	12	256	2P25U3H/12	12	256
2P18U3H/14	14	302	2P25U3H/14	14	302
2P18U3H/16	16	346	2P25U3H/16	16	346
2P18U3H/18	18	390	2P25U3H/18	18	390
2P18U3H/20	20	435	2P25U3H/20	20	435
2P18U3H/22	22	480	2P25U3H/22	22	480
2P18U3H/24	24	524	2P25U3H/24	24	524
2P18U3H/26	26	568	2P25U3H/26	26	568
2P18U3H/28	28	612	2P25U3H/28	28	612
2P18U3H/30	30	658	2P25U3H/30	30	658
2P18U3H/32	32	702	2P25U3H/32	32	702
2P18U3H/34	34	746	2P25U3H/34	34	746
2P18U3H/36	36	790	2P25U3H/36	36	790
2P18U3H/38	38	835	2P25U3H/38	38	835
2P18U3H/40	40	880	2P25U3H/40	40	880
2P18U3H/42	42	924	2P25U3H/42	42	924
2P18U3H/44	44	968	2P25U3H/44	44	968
2P18U3H/46	46	1012	2P25U3H/46	46	1012
2P18U3H/48	48	1058	2P25U3H/48	48	1058
2P18U3H/50	50	1102	2P25U3H/50	50	1102
2P18U3H/52	52	1146	2P25U3H/52	52	1146
2P18U3H/54	54	1192	2P25U3H/54	54	1192
2P18U3H/56	56	1235	2P25U3H/63	56	1235

ACCESSORIES

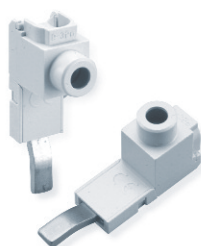

Type/Cat. No: **P50UT**
Description: Power Feed Lug



Type/Cat. No: **P50UB**
Description: Modular Direct Power Feed



Type/Cat. No: **BRB5W**
Description: Insulation Cap



Type/Cat. No: **18/25CAP3P**
Description: End Cap

UL 489

UL 508

UL 1077

UL 1077
Equipment Breakers

Earth Leakage
Circuit Breakers

ANNEX

3 PHASE BUSBAR - standard spacing

18mm² for 80A / 25mm² for 100A

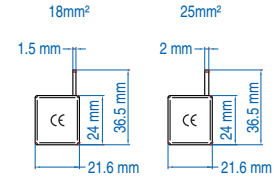
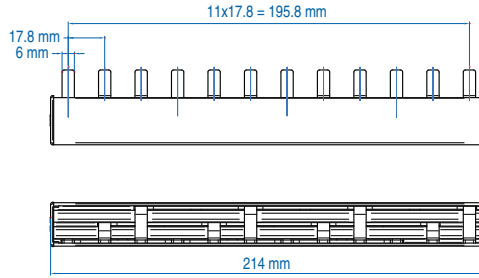

shown: 3P18U3/12

18mm² for 80A

25mm² for 100A

Type/ Cat. No.	No. of Pins	Length [mm]	Type/ Cat. No.	No. of Pins	Length [mm]
3P18U3/6	6	104	3P25U3/6	6	104
3P18U3/9	9	159	3P25U3/9	9	159
3P18U3/12	12	214	3P25U3/12	12	214
3P18U3/15	15	266	3P25U3/15	15	266
3P18U3/18	18	318	3P25U3/18	18	318
3P18U3/21	21	374	3P25U3/21	21	374
3P18U3/24	24	427	3P25U3/24	24	427
3P18U3/27	27	481	3P25U3/27	27	481
3P18U3/30	30	545	3P25U3/30	30	545
3P18U3/33	33	586	3P25U3/33	33	586
3P18U3/36	36	639	3P25U3/36	36	639
3P18U3/39	39	692	3P25U3/39	39	692
3P18U3/42	42	746	3P25U3/42	42	746
3P18U3/45	45	800	3P25U3/45	45	800
3P18U3/48	48	854	3P25U3/48	48	854
3P18U3/51	51	906	3P25U3/51	51	906
3P18U3/54	54	960	3P25U3/54	54	960
3P18U3/57	57	1012	3P25U3/57	57	1012

ACCESSORIES



Type/Cat. No:	P50UT	P50UB	P95UB
Description:	Power Feed Lug	Modular Direct Power Feed	Power Feed Block



Type/Cat. No:	BRB5W	18/25CAP3P
Description:	Insulation Cap	End Cap

3 PHASE BUSBAR - 1/2 pole spacing

18mm² for 80A / 25mm² for 100A

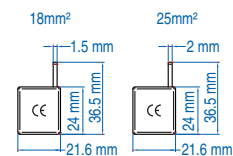
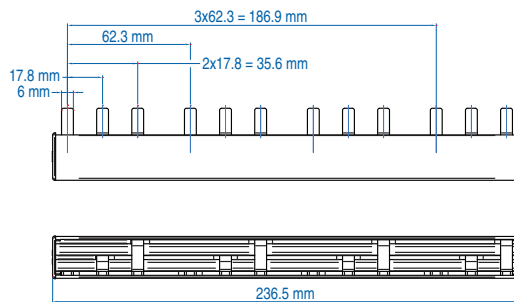

shown: 3P18U3H/12

UL 489

UL 508

UL 1077

UL 1077
Equipment Breakers

Earth Leakage
Circuit Breakers

ANNEX

18mm² for 80A

25mm² for 100A

Type/ Cat. No.	No. of Pins	Length [mm]	Type/ Cat. No.	No. of Pins	Length [mm]
3P18U3H/6	6	114	3P25U3H/6	6	114
3P18U3H/9	9	176	3P25U3H/9	9	176
3P18U3H/12	12	235	3P25U3H/12	12	235
3P18U3H/15	15	302	3P25U3H/15	15	302
3P18U3H/18	18	364	3P25U3H/18	18	364
3P18U3H/21	21	426	3P25U3H/21	21	426
3P18U3H/24	24	488	3P25U3H/24	24	488
3P18U3H/27	27	550	3P25U3H/27	27	550
3P18U3H/30	30	612	3P25U3H/30	30	612
3P18U3H/33	33	675	3P25U3H/33	33	675
3P18U3H/36	36	738	3P25U3H/36	36	738
3P18U3H/39	39	800	3P25U3H/39	39	800
3P18U3H/42	42	862	3P25U3H/42	42	862
3P18U3H/45	45	924	3P25U3H/45	45	924
3P18U3H/48	48	982	3P25U3H/48	48	982
3P18U3H/51	51	1048	3P25U3H/51	51	1048
3P18U3H/54	54	1112	3P25U3H/54	54	1112
3P18U3H/57	57	1174	3P25U3H/57	57	1174

ACCESSORIES

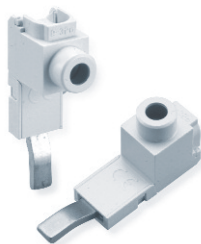

Type/Cat. No: **P50UT**
Description: Power Feed Lug



Type/Cat. No: **P50UB**
Description: Modular Direct Power Feed



Type/Cat. No: **BRB5W**
Description: Insulation Cap



Type/Cat. No: **18/25CAP3P**
Description: End Cap

Power Feed Devices

Easy connection of power supply wires to the busbar/MCB. Power Feed Devices ensure permanent connection.

Power Feed Lug



Power Feed Lug

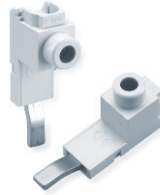

Modular Direct Power Feed



Type/Cat. No.	P50UT-LP	P50UT	P50UB
Electrical Ratings	115A/1000V AC/DC	115A/1000V AC/DC	115A/1000V AC/DC
Wire Range	10-1/0 AWG Cu	10-1/0 AWG Cu	14-1 AWG Cu
Wire Temperature Rating	60°C	60°C	75°C
Recommended/ Required Torque	5.6Nm (50lb. in.)	5.6Nm (50lb. in.)	Cable Side 3.5Nm/31 lb. in. (14-6AWG) 4Nm/35.4 lb. in. (4-1AWG) Busbar Side 2.5Nm/22 lb. in.
Material of Lug/ Terminal	Brass	Brass	Brass
Insulation Material	Polyamide	Polyamide	Polyamide
For use with	UL1077/508 18 and 25mm ² 1 phase busbars	UL1077/508 18 and 25mm ² 2, 3 phase busbars	UL1077/508 18 and 25mm ² 1, 2, 3 phase busbars

Dimensions

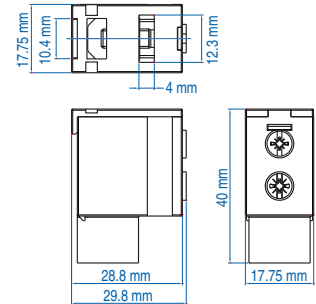
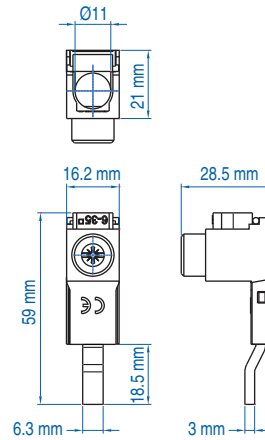
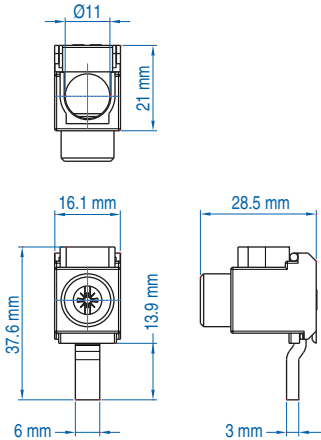

Assembly Instructions

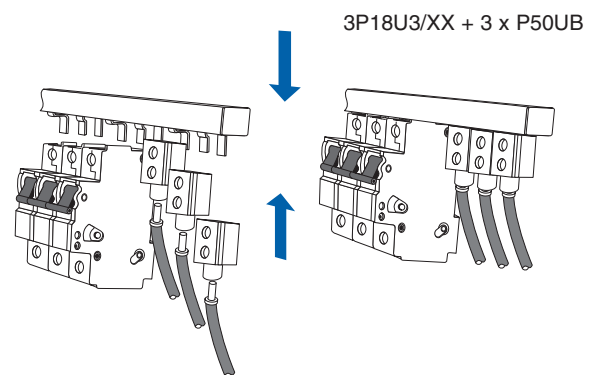
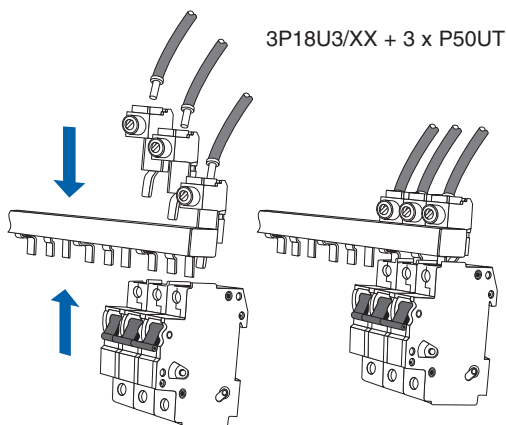

The power feed lugs (Cat. # P50UT) fit together with the lugs of the busbar in the terminals of the connected device.

Power Feed Block



Type/Cat. No.	P95UB
Electrical Ratings	200A/ 600V AC/DC
Wire Range	1-4/0 AWG Cu
Wire Temperature Rating	75°C
Recommended/ Required Torque	19.5Nm (175lb. in.)
Material of Lug/ Terminal	Brass
Insulation Material	Polyamide
For use with	UL1077/508 18 and 25mm ² 3 phase busbars (standard spacing only)

Dimensions

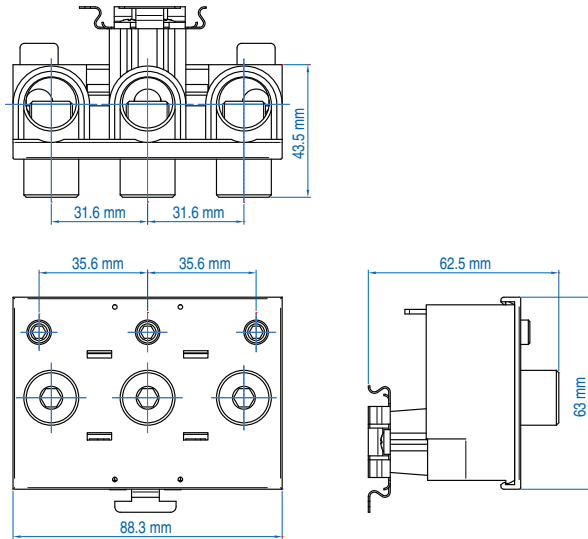

Assembly Instructions

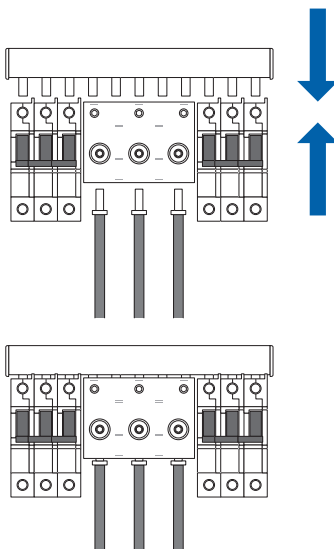

NOTE: The Power Feed Block uses the space of 5 Pins of the standard spacing Busbar (see drawing below). Phase 1 connects to Pin 1, Phase 2 to Pin 3 and Phase 3 to Pin 5. Pin 2 and 4 are not in use. Pin 6 should be covered with an insulation cap if phase sequence stays the same. Therefore, the Power Feed Block covers 6 pins to connect to the three phases.

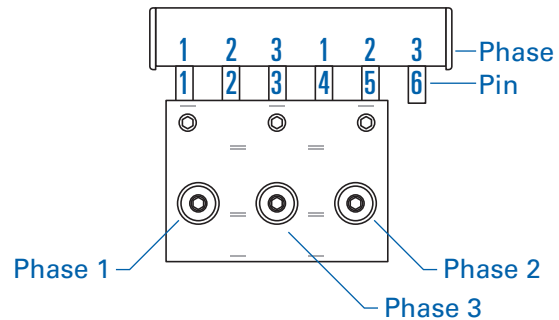

Miscellaneous Accessories

End Caps



18/25CAP1P

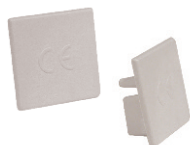

18/25CAP3P

Type/Cat. No: 18/25CAP1P
For use with: 18/25mm² 1 phase Busbar

Type/Cat. No: 18/25CAP3P
For use with: 18/25mm² 2, 3 phase Busbar

Insulation Caps



Type/Cat. No: BRB5W (5 per strip)
For use with: 18/25mm² 1, 2, 3 phase Busbar

UL 489

UL 508

UL 1077

UL 1077
Equipment Breakers

Earth Leakage
Circuit Breakers

ANNEX

TR11 Series

UL1077 Recognized Supplementary Protector/ Circuit Breaker for Equipment



E209569



up to 12 Amps

Applications:

Protection of Control Transformers, UPS, Power strips, Solenoids etc., against damage due to overload conditions.

Current Rating (A)	0.1 - 16A
Standard Current Rating (A)	0.1, 0.25, 0.5, 0.9, 1.0, 1.2, 1.5, 1.8, 2.0, 2.2, 2.5, 2.7, 3.0, 3.3, 4.0, 5.0, 6.0, 6.5, 7.0, 8.0, 9.0, 10.0, 12.0, 15.0, 16.0
Rated Voltage	240V AC, 50/60Hz, 50V DC / 24V DC (VDE)
Initial insulation resistance (500V DC)	> 100 M ohms. (As per EN 60934)
Dielectric strength	1.5 KV for One minute. (As per EN 60934)
Overload Switching Capacity	6 I _n - AC up to 9.0A 4 I _n - DC up to 12.0A (As per EN 60934) 60A AC/DC Max. - from 10.0A to 12.0A
Maximum Breaking Capacity	8x I _n AC/DC for <6.0A 60A AC/DC MAX. for > 6.0A
Power Loss	1 - 2 Watts
Operating Temperature	Maximum 60°C Ambient
Operational Life at 2xI _n	1000 Cycles
Rated Conditional Short Circuit Current Capacity I _{nc1} (PC1)	1000 Amps PC 1, 240V AC, 24V DC, Ref.: EN60934 SC: 1KA, C1, 240V AC 50V DC Ref.: EN60934 Ref.: CSA22.2 No.235-04, UL-1077
Tripping Current Code TC	TC 2 Ref.: CSA22.2 No. 235-04
Overload Rating	OL0 240V AC, 50V DC, Ref.: CSA22.2 No. 235-04
Application Type	General Industrial Ref.: CSA22.2 No. 235-04
Method of Tripping	Thermal 'TO' Trip Free
Type of Actuation	Reset Type 'R'
Application Standards	CSA 22.2 No. 235-04, UL-1077, EN 60934
Weight	aprox. 11g
Approvals	0.1 - 16.0A 240V AC 50V DC 0.5 - 12.0A 240V AC 24V DC

Operating Characteristic

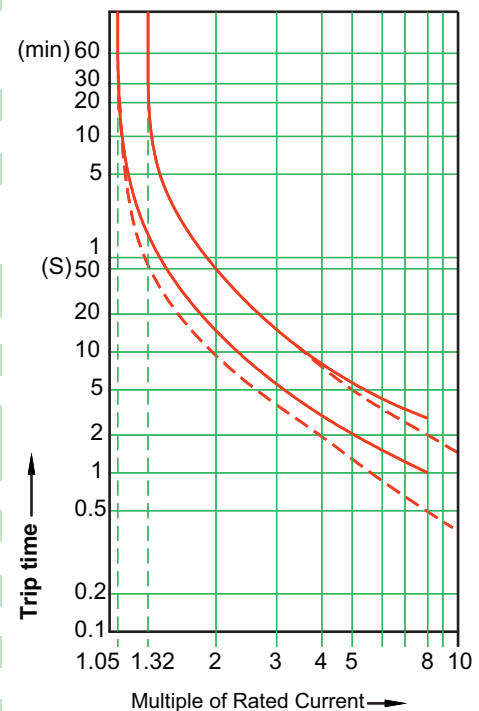

Rated current < 6 A
 - - - - - Ambient >= 6 A
 Temperature 23°C

ORDERING INSTRUCTIONS

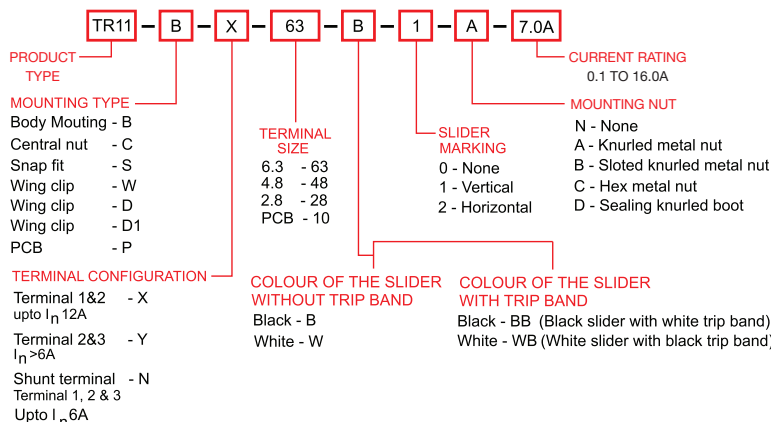

Time Current Characteristics:

The standard characteristic is valid for ambient temperatures of +23°C. If the device is to be used in an ambient temperature other than +23°C, allowances must be made when selecting the current rating according to the following guidelines:

Ambient temp. °C	-20	-5	0	+10	+20	+30	+40	+50	+60
Correction Factor	0.8	0.88	0.9	0.96	1	1.05	1.12	1.2	1.3

Example:	Normal Continuous Current	1.8A
	Ambient Temperature	40°C
	Correction Factor	1.12
	Recommended Current Rating	1.8 x 1.12 = 2.016
	Select the nearest	2.0A

* SPECIAL ORDER ONLY. Contact Altech for more details. TR11-C Series stocked; contact Altech for availability. PCB Mounting and additional Shunt Terminal available, please contact Altech.

TR-11 Dimensions & Mounting Options

Central Mounting

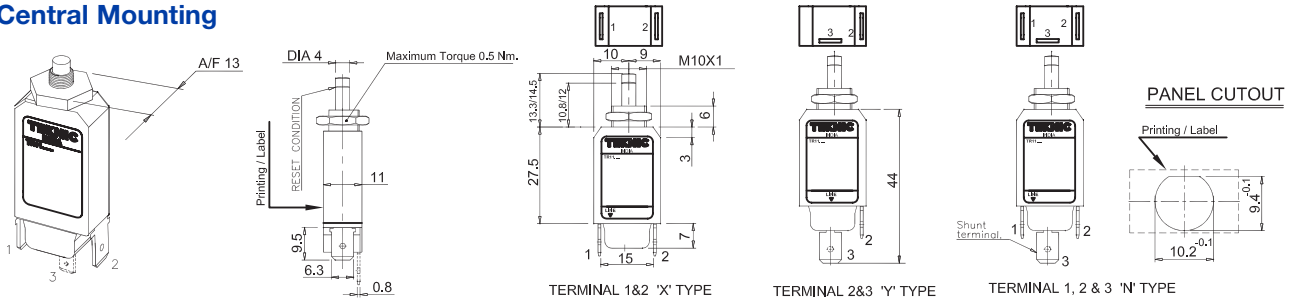

Wing Clips

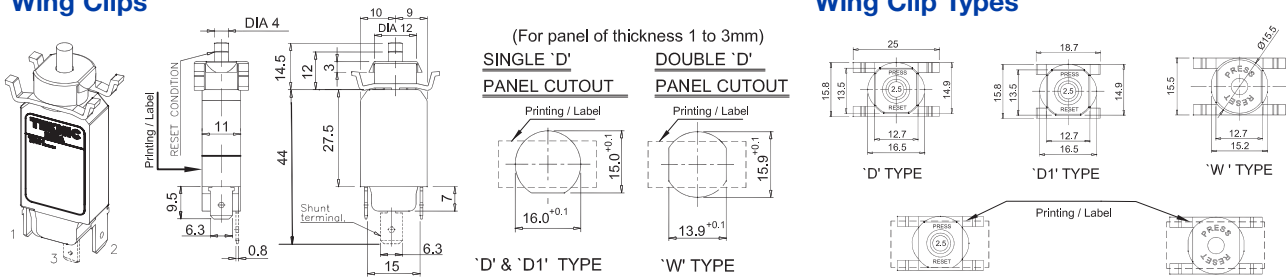

Snap Fitting

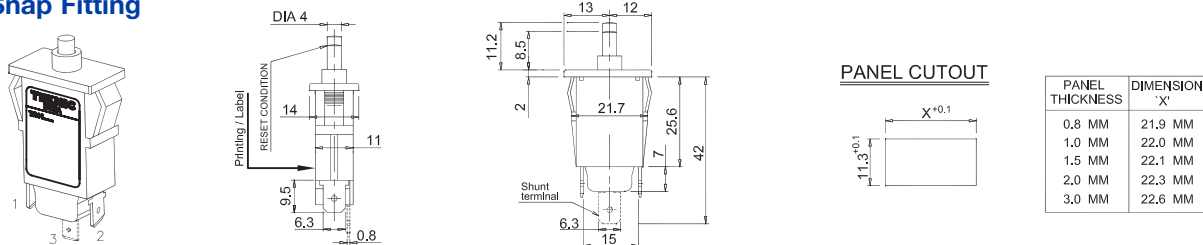

Body Mounting

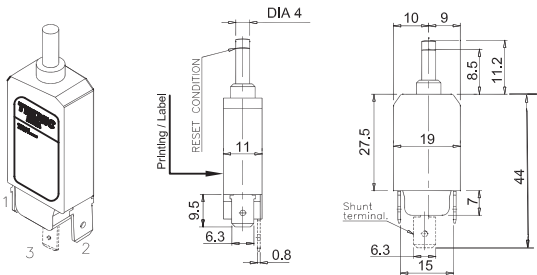

PCB Mounting

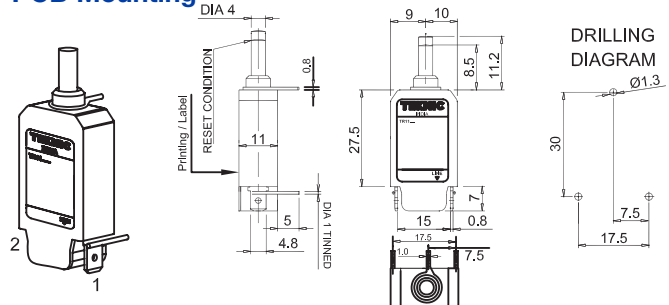

Slider Printing for Current Rating

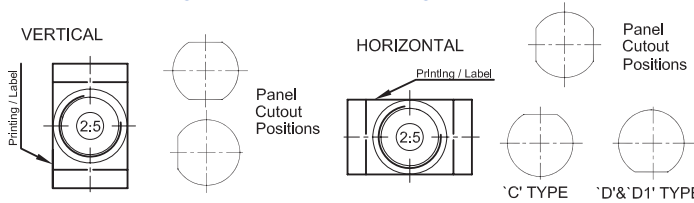

Slider Color with Trip Band

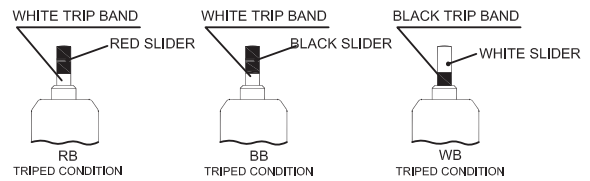

Accessories

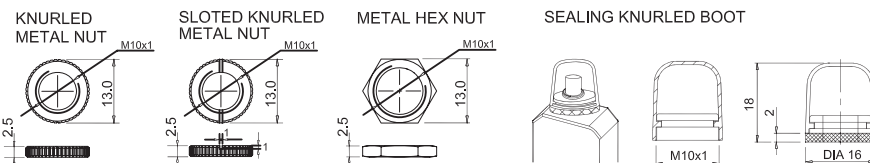

A sealing boot for central mounting Type (C) Circuit breaker to provide dust & splash protection (IP 54).

Dimensions in mm (to convert to inches multiply by 0.03937)

TR-11 Dimensions & Mounting Options

Central Mounting

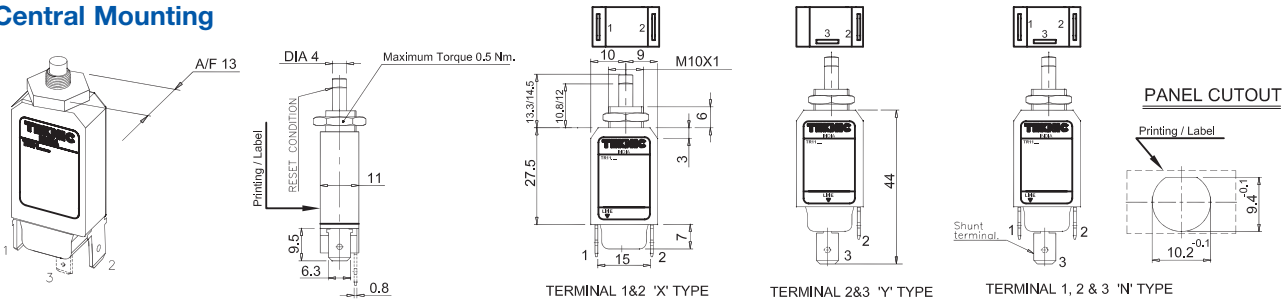

Wing Clips

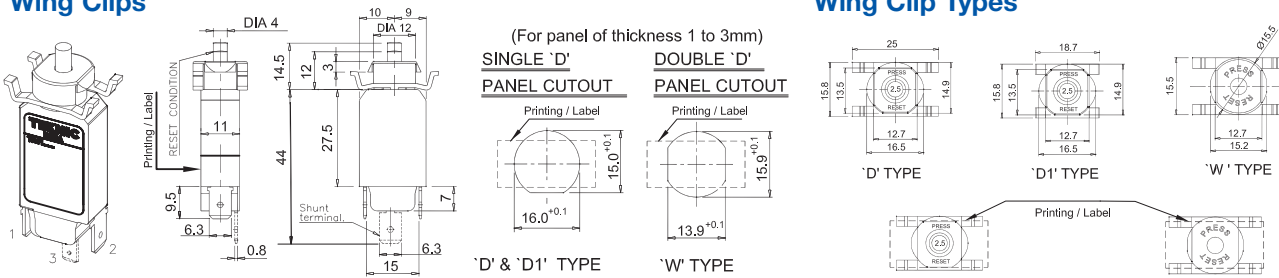

Wing Clip Types

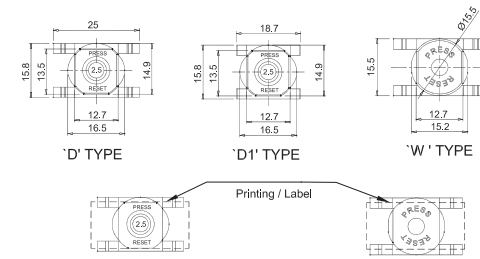

Snap Fitting

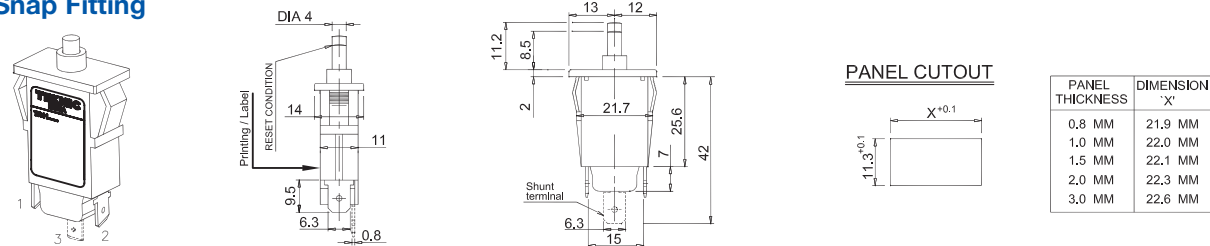

Body Mounting

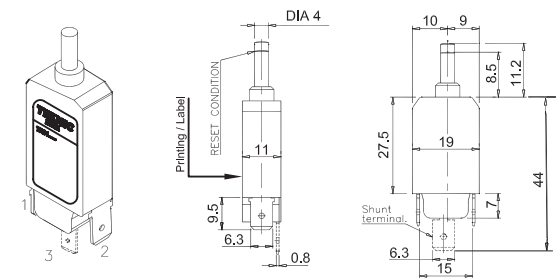

PCB Mounting

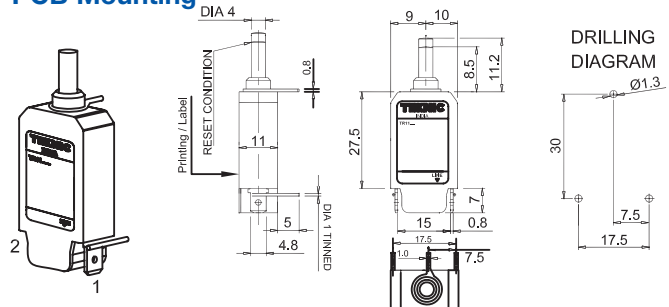

Slider Printing for Current Rating

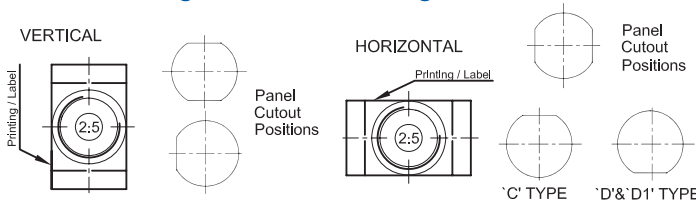

Slider Color with Trip Band

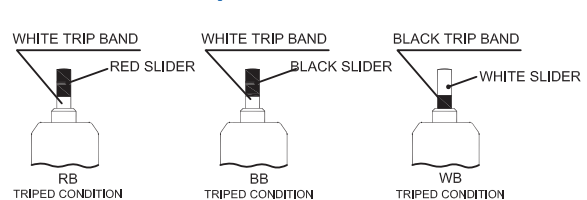

Accessories

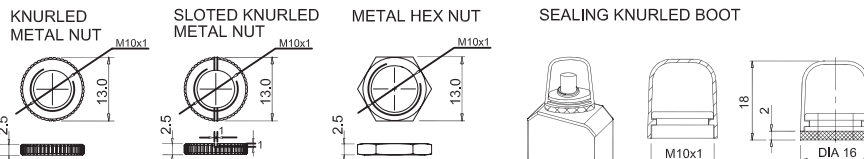

A sealing boot for central mounting Type (C) Circuit breaker to provide dust & splash protection (IP 54).



Dimensions in mm (to convert to inches multiply by 0.03937)

TR20 Series

UL1077 Recognized Supplementary Protector/ Circuit Breaker for Equipment

Applications:

Protection of Control Transformers, UPS, Power strips, Solenoids etc., against damage due to overload conditions.

Application Type	General Industrial Ref. CSA22.2 No.235-04
Function	SPST
Standard Current Rating (A)	3, 4, 5, 6, 7, 8, 10, 12, 15, 16 & 20 AC-Inductive, DC-Resistive
Rated Voltage	125/125V AC, 50/60 Hz, 50V DC
Method of tripping	Thermol TO, Cycling trip - free
Type of Actuation	Reset Type 'R'
Initial insulation resistance	> 100 M ohms. (DC500V)
Dielectric strength	1,500 KV for 1 minute
Impulse withstand voltage	2.5kV Ref.: EN 60934
Contact Gap	Micro disconnection(μ) Ref.: EN60934
Housing Material	Thermoplastic / Thermoset
Slider Material	Thermoset
Contact Material	Silver alloy
Terminal Material	Copper alloy
Fixing	By a nut or snap fitting
Resettable overload capacity	10 times the rated current
Overload capacity	2 times rated current for 50 switching cycles min. Ref.: UL 1077
Rated Short Circuit Capacity I_{cn}	Min 6 times the rated current ($6I_n$) for 250V AC (Inductive) Ref.: EN60934 Min 4 times the rated current ($4I_n$) for 50V DC (Resistive)
Rated Conditional Short Circuit Current Capacity I_{nc1} (PC1)	1000 Amps 125/250V AC, 50V DC SC: 1kA, C1, 125/250V AC, 50V AC Ref.: CSA22.2 No.235-04, UL-1077
Tripping Current Code TC	TC 2 Ref.: CSA22.2 No. 235-04
Overload Rating	OLO 125/250V AC, 50V DC, Ref.: CSA 22.2 No. 235-04
Weight	aprox. 17g
Application Standards	UL 1077, CSA 22.2 No. 235-04, EN 60934
Approvals	  



E209569



up to 12 Amps

Operating Characteristic

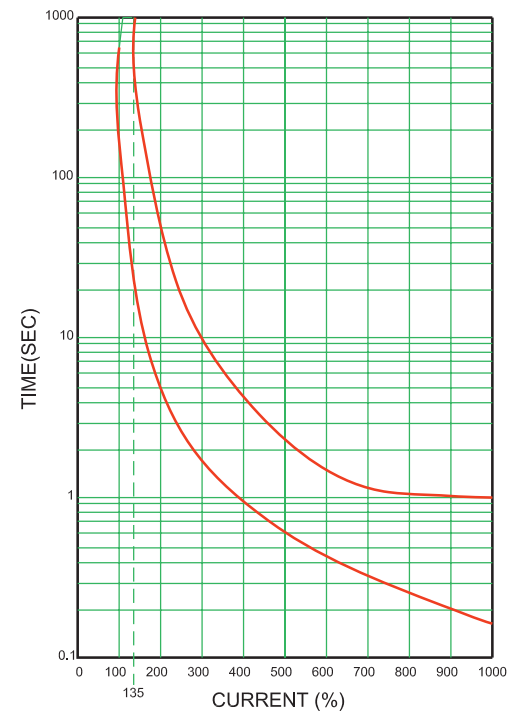

ORDERING INSTRUCTIONS

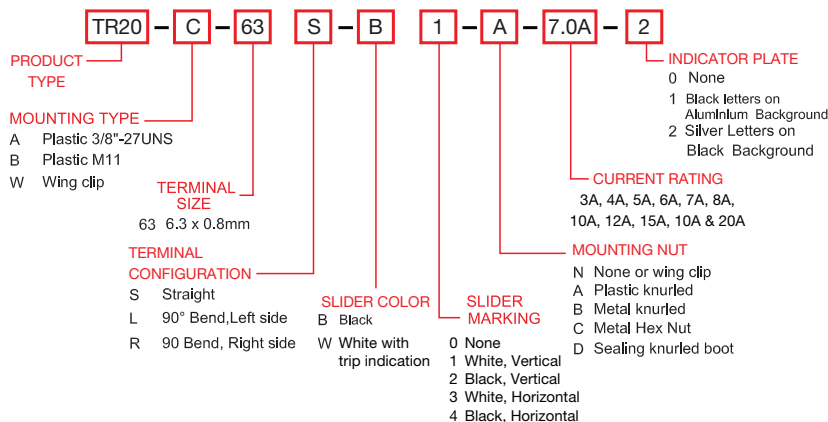

Time Current Characteristics:

The standard characteristic is valid for ambient temperatures of +25°C. If the device is to be used in an ambient temperature other than +25°C, allowances must be made when selecting the current rating according to the following guidelines:

Ambient temp. °C	-20	-10	0	+10	+25	+30	+35
Multiplication Factor 3A to 4A	0.8	0.85	0.9	0.9	1	1	1.1
Multiplication Factor 5A to 20A	0.8	0.85	0.88	0.9	1	1.1	1.3
Example: Normal Continuous Current					5.0A		
Ambient Temperature					40°C		
Multiplication Factor					1.1		
Selected rated current at +40°C					5 x 1.1 = 5.5		
Ambient temperature					6.0A (nearest)		

* SPECIAL ORDER ONLY. Contact Altech for more details.

PCB Mounting and additional Shunt Terminal available, please contact Altech.

TR-20 Dimensions & Mounting Options

Central Mounting

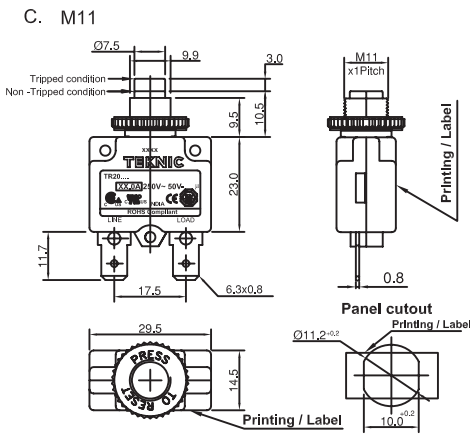
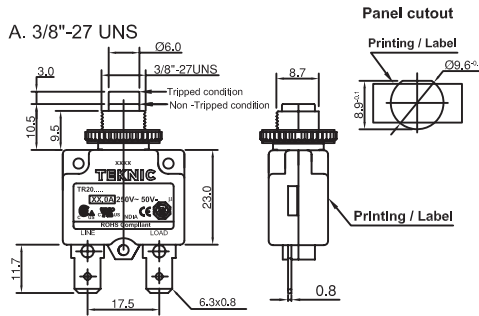

Wing Clips

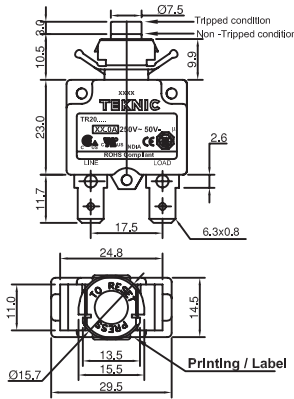

PANEL CUTOUT

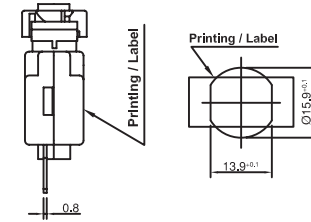

PANEL THICKNESS 1 TO 3MM.

Terminal Options

S. STRAIGHT

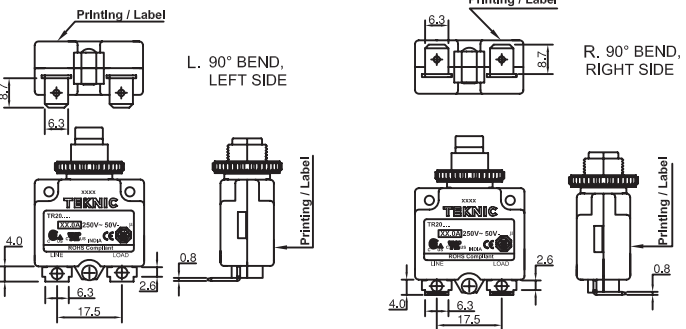
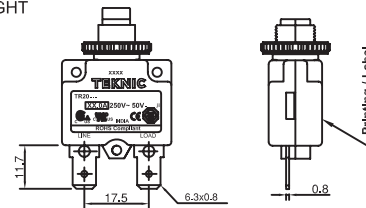

Slider Printing for Current Rating

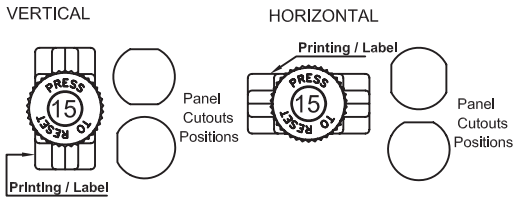

Accessories

PLASTIC NUT

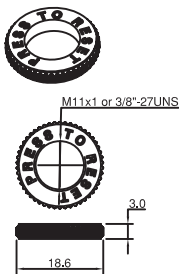

METAL NUT

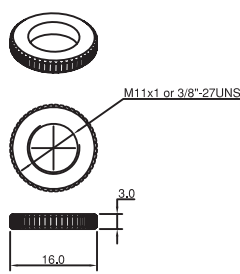

METAL HEX NUT

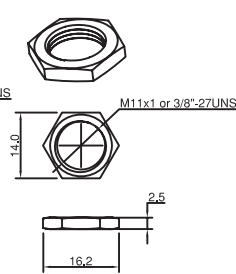

SEALING KNURLED BOOT

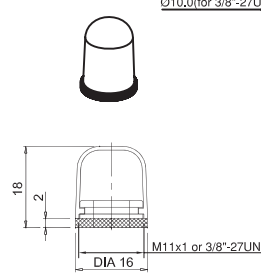

INDICATOR PLATE

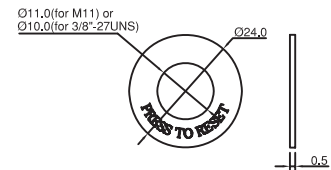

TYPES:

- A. Black letters on Aluminium Background.
- B. Silver Letters on Black Background.

Dimensions in mm (to convert to inches multiply by 0.03937)

UL 489

UL 508

UL 1077

UL 1077
Equipment Breakers

Earth Leakage
Circuit Breakers

ANNEX

TR30 Series

UL1077 Recognized Supplementary Protector/ Circuit Breaker for Equipment

Applications:

Protection of Control Transformers, UPS, Power strips, Solenoids etc., against damage due to overload conditions.

Application Type	General Industrial Ref. CSA22.2 No.235-04
Function	SPST
Standard Current Rating (A)	5A-25A 5A, 6A, 7A, 10A, 12A, 15A, 20A, 25A, 30A & 35A
Rated Voltage	125/125V AC, 50/60 Hz, 50V DC
Method of tripping	Thermol TO, Cycling trip - free
Type of Actuation	Reset Type 'R'
Initial insulation resistance	> 100 M ohms. (DC500V)
Dielectric strength	1.500 KV for 1 minute
Impulse withstand voltage	2.5kV Ref.: EN 60934
Contact Gap	Micro disconnection(μ) Ref.: EN60934
Housing Material	Thermoset - UL94-V0 flammability class
Slider Material	Thermoset - UL94-V0 flammability class
Contact Material	Silver alloy
Terminal Material	Copper alloy
Fixing	By a nut or snap fitting
Resettable overload capacity	10 times the rated current
Rated Short Circuit Capacity I _{cn}	Min 6 times the rated current (6 _{In}) for 250V AC (Inductive) Ref.: EN60934 Min 4 times the rated current (4 _{In}) for 50V DC (Resistive)
Rated Conditional Short Circuit Current Capacity I _{nc1} (PC1)	1kA, 5 to 15A, 250V AC, 2kA, 20 to 35A, 250V AC, As per EN60934 1kA, 5 to 35A, 50V DC As per CSA 22.2 No. 235-04 & UL 1077 1kA, C1, 50V Dc, -(5-35A); 500A, U3, 125V AC, -(20-35A); 1kA, U1a, 125V AC, -(5-35A); 2kA, C1, 125V AC, -(5-35A); 1kA, C1, 250V AC, -(5-15A); 2kA, C1, 250V AC, -(20-35A)
Tripping Current Code TC	TC 3 Ref.: CSA22.2 No. 235-04
Overload Rating	5-35A - OL0 125/250V AC, 50V DC; As per CSA 22.2 No. 235-04 5-35A - OL1 125V AC; 5-35A - OL1 250V AC
Weight	aprox. 25g
Application Standards	UL 1077, CSA 22.2 No. 235-04, EN 60934, UL 1500
Approvals	

Ignition Protected Compliant as per UL 1500
(Standard for safety for Ignition protection test for Marine products)

ORDERING INSTRUCTIONS

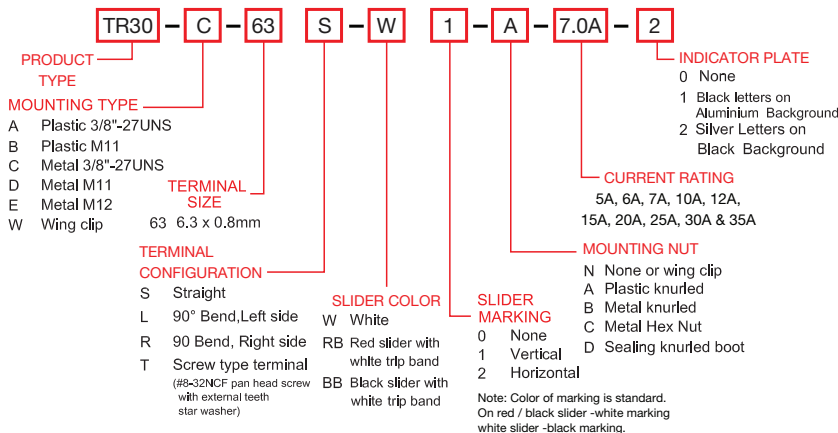

* SPECIAL ORDER ONLY. Contact Altech for more details.
PCB Mounting and additional Shunt Terminal available, please contact Altech.



up to 12 Amps

Operating Characteristic

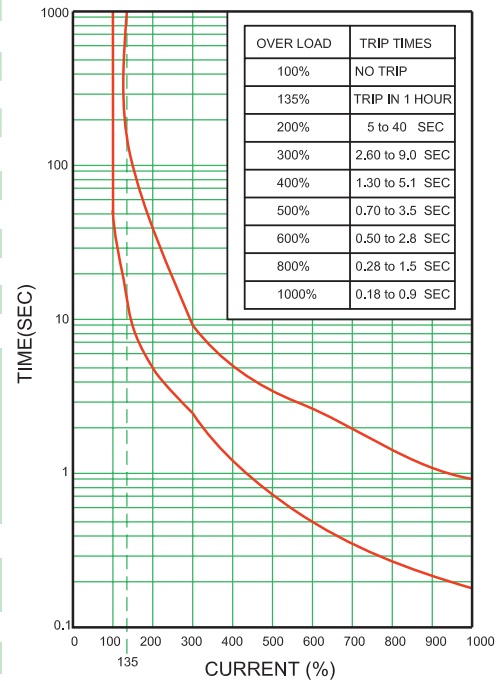

Time Current Characteristics:

The standard characteristic is valid for ambient temperatures of +25°C. If the device is to be used in an ambient temperature other than +25°C, allowances must be made when selecting the current rating according to the following guidelines:

Ambient temp. °C	-5	-0	+10	+20	+25	+30	+40	+50	+60
Multiplication Factor 5A	0.9	0.92	0.95	0.98	1	1.12	1.15	1.25	1.5
Multiplication Factor 56A to 30A	0.9	0.92	0.95	0.98	1	1.05	1.15	1.25	1.35
Multiplication Factor 35A	0.9	0.93	0.95	0.98	1	1.05	1.15	1.25	1.35

Example: Normal Continuous Current 5.0A
Ambient Temperature 40°C
Multiplication Factor 1.15
Selected rated current at +40°C ambient temperature 5 x 1.15 = 5.75
6.0A (nearest)

TR-30 Dimensions & Mounting Options

Central Mounting

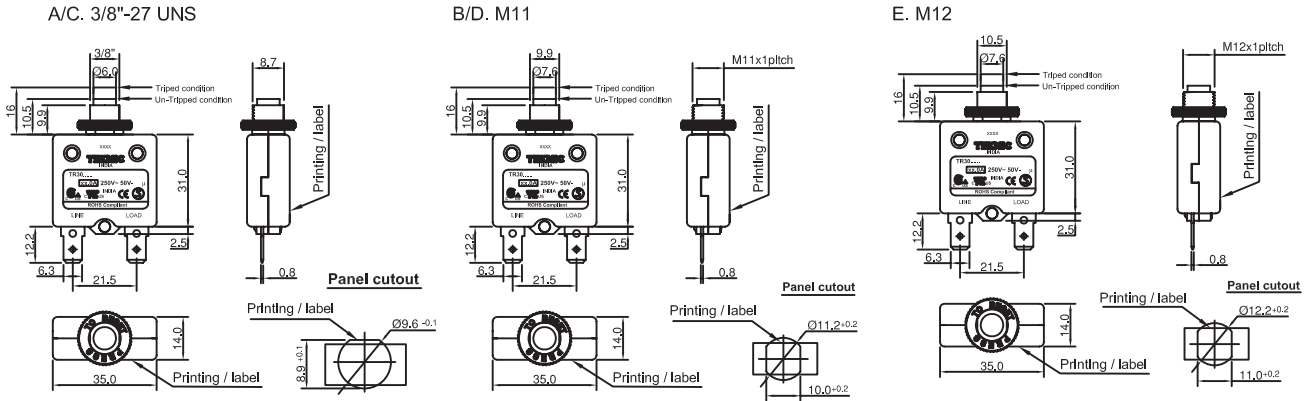

Wing Clips

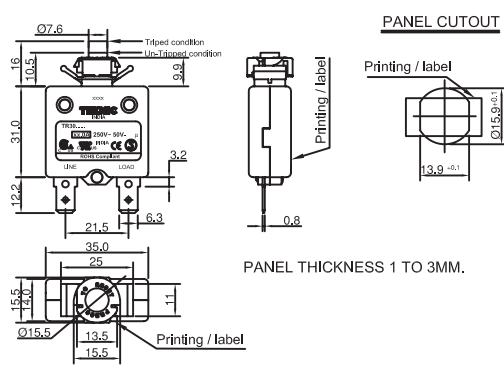

Terminal Options

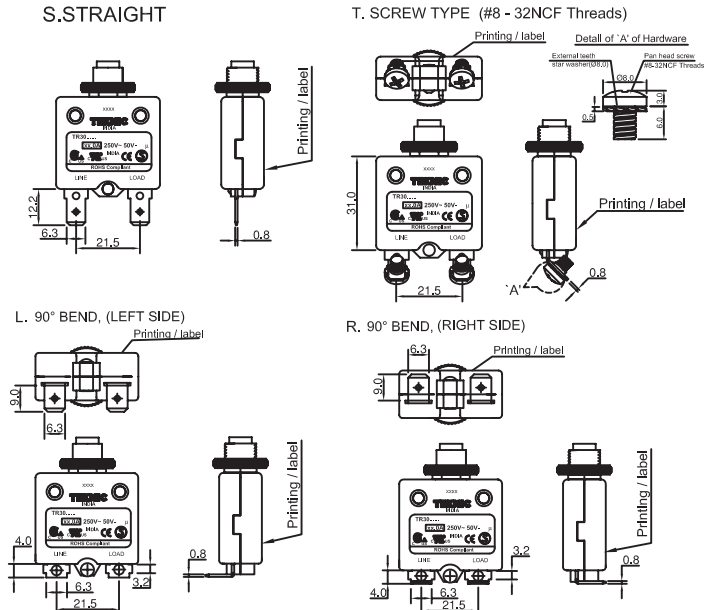

Slider Printing for Current Rating

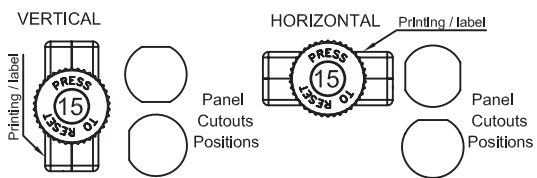

Accessories

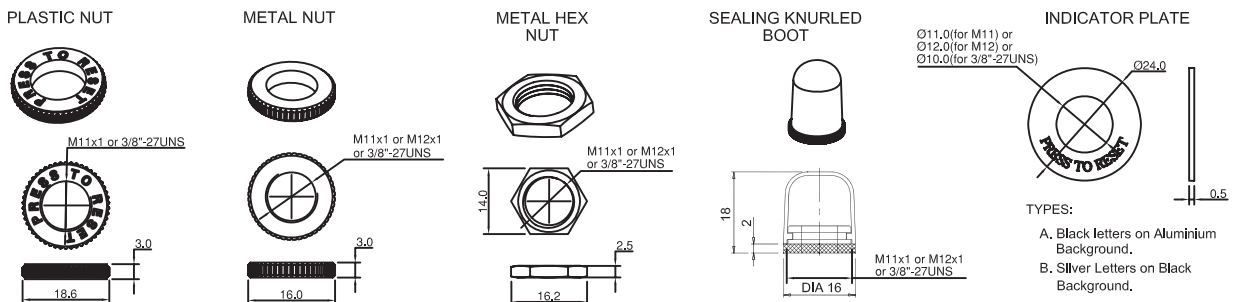

Dimensions in mm (to convert to inches multiply by 0.03937)

RP - Series RCCB Earth Leakage Circuit Breakers

RCCB Series compact Earth Leakage Circuit Breakers detect and interrupt earth (ground) faults. They are VDE approved for the European system of protecting people, animals, equipment and property from dangerous line-to-ground and shock hazard currents.

US applications include ground-fault protection of equipment (GFPE) using the 10mA and 30mA fault current ratings, especially when high distributed capacitance or other leakages cause excessive nuisance trips at lower fault currents. Applications for the 300mA and 500mA ratings are equipment protection and fire prevention, limiting the energy of a fault to less than the minimum ignition energy for many materials.

Type Designation

- RP** $\overline{(a)}$ $\overline{(b)}$ $\overline{(c)}$
- (a) = 2-2 pole; 4-4 pole
 - (b) = 1-16A; 2-25A; 3-40A; 4-63A; 5-80A; 6-100A; 7-125A
 - (c) = 01 - 10mA
= 03 - 30mA
= 30 - 300mA
= 50 - 500mA



RP2



RP4



Maximum Rated Line Current	Fault Trip Current	Cat. No.	Fault Trip Current	Cat. No.
16A	10mA	RP2101		
25A	30mA	RP2203	30mA	RP4203
25A	300mA	RP2230	300mA	RP4230
25A			500mA	RP4250
40A	30mA	RP2303	30mA	RP4303
40A	300mA	RP2330	300mA	RP4330
40A			500mA	RP4350
63A	30mA	RP2403	30mA	RP4403
63A	300mA	RP2430	300mA	RP4430
63A	500mA	RP2450	500mA	RP4450
80A			30mA	RP4503
80A			300mA	RP4530
80A			500mA	RP4550
100A			30mA	RP4603
100A			300mA	RP4630
100A			500mA	RP4650
125A			30mA	RP4703
125A			300mA	RP4730
125A			500mA	RP4750

Stock items are shown in BOLD.

Voltage Rating (maximum)	230V AC, 50Hz	400Y/230V AC, 50Hz
Short Circuit Withstand Rating	No back-up fuse: Rated current (RC) 16/25/40A: 500A; RC 63/80A: 800A; RC 100A: 1000A; RC 125A-1250A. With back-up fuse: 10kA; Size of fuse: (2 pole version): RC 25/40/63: 100A; (4 pole version): RC 25/40/63A: 100A; RC 80/100/125A: 125A	
Fault Trip Current Calibration	FI trips are calibrated at less than fault trip current for ensured safety (Typical trip range between 66.6-83.3% fault trip current, e.g., typical trip at 20-25mA for fault RC of 30mA)	
Typical Life	Fully functional after 5,000 operations to DIN/VDE 0664T10, IEC 61008-1 and 2000 additional fault current trips.	
Standard Pack and Weight	1/230g (0.6 lb.)	1/420-460g (0.9 lb.-1.0 lb.)
Terminal Size Acceptability	1.5-50mm ² (16-1 AWG)	1.5-50mm ² (16-1 AWG)
Terminal Torque	3Nm (26.5 lb.in.)	3Nm (26.5 lb.in.)

Circuit Diagram

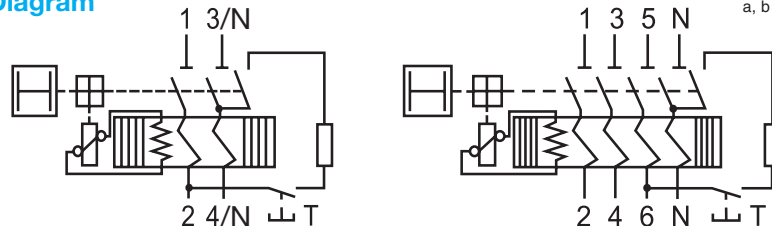

- a For 2-Phase applications, terminal 5 and 6 (next to Neutral terminals) must be connected to one phase for the test circuit to be operable.
- b For voltage systems without a neutral conductor. Please use jumper from "1" or "3" to top "N" terminal. This will assure proper functioning of the "test" circuit.



Note: If the power system has a marked conductor, it must connect through the FI and not be grounded at any point downstream.

RH11 - Auxiliary Contact and Signal Switch (switchable) (C.O./N.C.)

Contact Rating	Wire Size	Torque	Cat. No.	Circuit Diagram
6A / 230V AC 1A / 110V DC Std. Pk.: 1 Unit Weight: 45 grams (0.12 lb.) Width: 9mm (.354in.)	1-1.5mm ² (16 AWG)	max. 0.8Nm (7lb.in.)	RH11	

Dimensions in mm

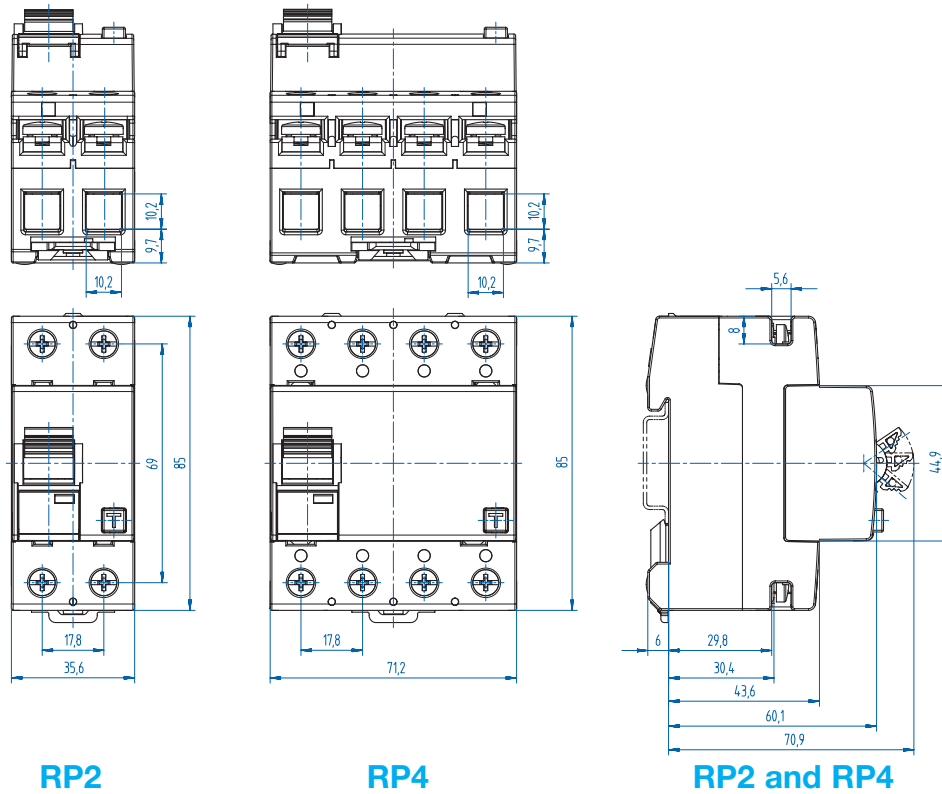

RP2

RP4

RP2 and RP4

Temperature Range	Environmental Information marked with “Snowflake” approval for -25°C to 40°C (-13°F to 104°F) ambient temperature. (Temperature effect on RC: for every 10°C temperature rise above 40°C decrease RC by 7%.)
Fluctuating Climate Conditions	According to IEC 60068-2-30: heat (25°C–55°C), relative humidity (93%–95%)
Electrical Shock Protection	Uninsulated electrically live parts within 30mm of the operating handle are “finger safe” (terminal screw heads) and uninsulated live parts within 100mm of the operating handle are “back-of-hand safe” (terminals).
Impact/Shock Protection	20g with impact force half-cycle sinusoidal and 20ms duration, 18 impacts total with 6 on each principal axis (3 impacts each face). FI is DIN Rail mounted during the test, and electrically loaded with 25% of Fault RC. Successful testing required no trip during the test, no damage and no loosened parts.
Vibration/Seismic Resistance	5g, at frequency of ≤80Hz, applied for 30 minutes along each of the three principal axes, plus 5 minutes of application at every established critical resonant frequency. FI is DIN Rail mounted during the test, and loaded with 25% Fault RC. To pass, the FI did not trip at 25% Fault RC, but did trip between each of the principal axis tests when the fault current was raised to 125% Fault RC, and there was no damage and no loosened parts. Suitable for machinery and mobile vehicle applications.
Protection Class	IP20; higher protection Class is dependent on housing.
Non-Sinusoidal Fault	The FI is tested and approval stamped for tripping sensitivity to non-sinusoidal fault currents, which become zero or almost zero within one cycle of the line frequency. Waveforms and allowed trip-current ranges are as follows: <ul style="list-style-type: none"> 1. AC Sinusoidal Fault - 0.5-1.0 times Fault RC 2a. Pulsating DC Fault; Positive and Negative Half-Waves - 0.35-1.4 times Fault RC 2b. Phased Half-Wave, 90° - 0.25-1.4 times Fault RC Phased Half-Wave, 135° - 0.11-1.4 times Fault RC 3. Pulsating DC on 6mA DC (continuous) Base - Max. 1.4 times Fault RC + 6mA
Insulation Category	At VDE rated voltage, suitable for Class C environments with relatively high dust and moisture levels and little HVAC control, e.g., industrial, commercial, agricultural; on machine tools, hoists, warehouse equipment, etc.; in boiler rooms, unheated storage, covered shipping/receiving, open workshops, etc.

UL 489

UL 508

UL 1077

UL 1077
Equipment Breakers

Earth Leakage
Circuit Breakers

ANNEX

Index

UL 489

UL 508

UL 1077

UL 1077
Equipment Breakers

Earth Leakage
Circuit Breakers

ANNEX

Part No.	Page	Part No.	Page	Part No.	Page	Part No.	Page	Part No.	Page	Part No.	Page
15.960	16	1BU13R	64	1C1UL	12	1C63DL	14	1CU60R	65	1D25UR	58
15.960	59	1BU15R	64	1C1UM	39	1C63UL	12	1CU63L	22	1D2DL	15
18/25CAP1P	79	1BU16R	64	1C1UR	57	1C63UM	39	1CU63R	65	1D2UL	13
18/25CAP3P	79	1BU1R	64	1C2.5UM	39	1C63UR	57	1CU6L	22	1D2UM	40
1B05UR	56	1BU20R	64	1C20DL	14	1C6DL	14	1CU6R	65	1D2UR	58
1B1.6UM	38	1BU25R	64	1C20UL	12	1C6UL	12	1CU8L	22	1D3.5UM	40
1B10UM	38	1BU2R	64	1C20UM	39	1C6UM	39	1CU8R	65	1D30DL	15
1B10UR	56	1BU30R	64	1C20UR	57	1C6UR	57	1D03DL	15	1D30UL	13
1B12UR	56	1BU32R	64	1C25DL	14	1C8DL	14	1D03UL	13	1D30UM	40
1B13UM	38	1BU3R	64	1C25UL	12	1C8UL	12	1D03UM	40	1D30UR	58
1B13UR	56	1BU40R	64	1C25UM	39	1C8UM	39	1D05DL	15	1D32DL	15
1B15UM	38	1BU4R	64	1C25UR	57	1C8UR	57	1D05UL	13	1D32UL	13
1B15UR	56	1BU50R	64	1C2DL	14	1CU02L	22	1D05UM	40	1D32UM	40
1B16UM	38	1BU5R	64	1C2UL	12	1CU05L	22	1D05UR	58	1D32UR	58
1B16UR	56	1BU60R	64	1C2UM	39	1CU05R	65	1D075UM	40	1D3DL	15
1B1UM	38	1BU63R	64	1C2UR	57	1CU1.6L	22	1D1.6DL	15	1D3UL	13
1B1UR	56	1BU6R	64	1C3.5UM	39	1CU10L	22	1D1.6UL	13	1D3UM	40
1B2.5UM	38	1BU8R	64	1C30DL	14	1CU10R	65	1D1.6UM	40	1D3UR	58
1B20UM	38	1C03DL	14	1C30UL	12	1CU12L	22	1D10DL	15	1D40DL	15
1B20UR	56	1C03UL	12	1C30UM	39	1CU12R	65	1D10UL	13	1D40UL	13
1B25UR	56	1C03UM	39	1C30UR	57	1CU13L	22	1D10UM	40	1D40UM	40
1B25UZ	38	1C05DL	14	1C32DL	14	1CU13R	65	1D10UR	58	1D40UR	58
1B2UM	38	1C05UL	12	1C32UL	12	1CU15L	22	1D12DL	15	1D4DL	15
1B2UR	56	1C05UM	39	1C32UM	39	1CU15R	65	1D12UL	13	1D4UL	13
1B3.5UM	38	1C05UR	57	1C32UR	57	1CU16L	22	1D12UR	58	1D4UM	40
1B30UM	38	1C075UM	39	1C3DL	14	1CU16R	65	1D13DL	15	1D4UR	58
1B30UR	56	1C1.6DL	14	1C3UL	12	1CU1L	22	1D13UL	13	1D50DL	15
1B32UM	38	1C1.6UL	12	1C3UM	39	1CU1R	65	1D13UM	40	1D50UL	13
1B32UR	56	1C1.6UM	39	1C3UR	57	1CU20L	22	1D13UR	58	1D50UM	40
1B3UM	38	1C10DL	14	1C40DL	14	1CU20R	65	1D15DL	15	1D50UR	58
1B3UR	56	1C10UL	12	1C40UL	12	1CU25L	22	1D15UL	13	1D5DL	15
1B40UM	38	1C10UM	39	1C40UM	39	1CU25R	65	1D15UM	40	1D5UL	13
1B40UR	56	1C10UR	57	1C40UR	57	1CU2L	22	1D15UR	58	1D5UM	40
1B4UM	38	1C12DL	14	1C4DL	14	1CU2R	65	1D16DL	15	1D5UR	58
1B4UR	56	1C12UL	12	1C4UL	12	1CU30L	22	1D16UL	13	1D60DL	15
1B50UM	38	1C12UR	57	1C4UM	39	1CU30R	65	1D16UM	40	1D60UL	13
1B50UR	56	1C13DL	14	1C4UR	57	1CU32L	22	1D16UR	58	1D60UM	40
1B5UM	38	1C13UL	12	1C50DL	14	1CU32R	65	1D1DL	15	1D60UR	58
1B5UR	56	1C13UM	39	1C50UL	12	1CU3L	22	1D1UL	13	1D63DL	15
1B60UM	38	1C13UR	57	1C50UM	39	1CU3R	65	1D1UM	40	1D63UL	13
1B60UR	56	1C15DL	14	1C50UR	57	1CU40L	22	1D1UR	58	1D63UM	40
1B63UM	38	1C15UL	12	1C5DL	14	1CU40R	65	1D2.5UM	40	1D63UR	58
1B63UR	56	1C15UM	39	1C5UL	12	1CU4L	22	1D20DL	15	1D6DL	15
1B6UM	38	1C15UR	57	1C5UM	39	1CU4R	65	1D20UL	13	1D6UL	13
1B6UR	56	1C16DL	14	1C5UR	57	1CU50L	22	1D20UM	40	1D6UM	40
1B8UR	56	1C16UL	12	1C60DL	14	1CU50R	65	1D20UR	58	1D6UR	58
1BU05R	64	1C16UM	39	1C60UL	12	1CU5L	22	1D25DL	15	1D8DL	15
1BU10R	64	1C16UR	57	1C60UM	39	1CU5R	65	1D25UL	13	1D8UL	13
1BU12R	64	1C1DL	14	1C60UR	57	1CU60L	22	1D25UM	40	1D8UM	40

Index

Part No.	Page	Part No.	Page	Part No.	Page	Part No.	Page	Part No.	Page	Part No.	Page
1D8UR	58	1E10UM	41	1P16UL3/18	30	1P18U1/53	72	1Z12UM	43	2B4UR	56
1DU02L	23	1E12UM	41	1P16UL3/6	30	1P18U1/54	72	1Z13UM	43	2B50UM	38
1DU05L	23	1E13UM	41	1P18U1/10	72	1P18U1/55	72	1Z15UM	43	2B50UR	56
1DU05R	66	1E15UM	41	1P18U1/11	72	1P18U1/56	72	1Z16UM	43	2B5UM	38
1DU1.6L	23	1E16UM	41	1P18U1/12	72	1P18U1/57	72	1Z1UM	43	2B5UR	56
1DU10L	23	1E1UM	41	1P18U1/13	72	1P18U1/6	72	1Z2.5UM	43	2B60UM	38
1DU10R	66	1E2.5UM	41	1P18U1/14	72	1P18U1/7	72	1Z20UM	43	2B60UR	56
1DU12L	23	1E20UM	41	1P18U1/15	72	1P18U1/8	72	1Z25UM	43	2B63UM	38
1DU12R	66	1E25UM	41	1P18U1/16	72	1P18U1/9	72	1Z2UM	43	2B63UR	56
1DU13L	23	1E2UM	41	1P18U1/17	72	1P18U1H/10	73	1Z3.5UM	43	2B6UM	38
1DU13R	66	1E3.5UM	41	1P18U1/18	72	1P18U1H/11	73	1Z30UM	43	2B6UR	56
1DU15L	23	1E30UM	41	1P18U1/19	72	1P18U1H/12	73	1Z32UM	43	2B8UR	56
1DU15R	66	1E32UM	41	1P18U1/2	72	1P18U1H/13	73	1Z3UM	43	2BU05R	64
1DU16L	23	1E3UM	41	1P18U1/20	72	1P18U1H/14	73	1Z40UM	43	2BU10R	64
1DU16R	66	1E40UM	41	1P18U1/21	72	1P18U1H/15	73	1Z4UM	43	2BU12R	64
1DU1L	23	1E4UM	41	1P18U1/22	72	1P18U1H/16	73	1Z50UM	43	2BU13R	64
1DU1R	66	1E50UM	41	1P18U1/23	72	1P18U1H/17	73	1Z5UM	43	2BU15R	64
1DU20L	23	1E5UM	41	1P18U1/24	72	1P18U1H/18	73	1Z6UM	43	2BU16R	64
1DU20R	66	1E60UM	41	1P18U1/25	72	1P18U1H/19	73	1Z8UM	43	2BU1R	64
1DU25L	23	1E63UM	41	1P18U1/26	72	1P18U1H/2	73	2B05UR	56	2BU20R	64
1DU25R	66	1E6UM	41	1P18U1/27	72	1P18U1H/20	73	2B1.6UM	38	2BU25R	64
1DU2L	23	1E8UM	41	1P18U1/28	72	1P18U1H/21	73	2B10UM	38	2BU2R	64
1DU2R	66	1G03UM	42	1P18U1/29	72	1P18U1H/22	73	2B10UR	56	2BU30R	64
1DU30L	23	1G05UM	42	1P18U1/3	72	1P18U1H/23	73	2B12UR	56	2BU32R	64
1DU30R	66	1G08UM	42	1P18U1/30	72	1P18U1H/24	73	2B13UM	38	2BU3R	64
1DU32L	23	1G1.6UM	42	1P18U1/31	72	1P18U1H/25	73	2B13UR	56	2BU40R	64
1DU32R	66	1G10UM	42	1P18U1/32	72	1P18U1H/26	73	2B15UM	38	2BU4R	64
1DU3L	23	1G12UM	42	1P18U1/33	72	1P18U1H/27	73	2B15UR	56	2BU50R	64
1DU3R	66	1G13UM	42	1P18U1/34	72	1P18U1H/28	73	2B16UM	38	2BU5R	64
1DU40L	23	1G15UM	42	1P18U1/35	72	1P18U1H/29	73	2B16UR	56	2BU60R	64
1DU40R	66	1G16UM	42	1P18U1/36	72	1P18U1H/3	73	2B1UM	38	2BU63R	64
1DU4L	23	1G1UM	42	1P18U1/37	72	1P18U1H/30	73	2B1UR	56	2BU6R	64
1DU4R	66	1G2.5UM	42	1P18U1/38	72	1P18U1H/31	73	2B2.5UM	38	2BU8R	64
1DU50L	23	1G20UM	42	1P18U1/39	72	1P18U1H/32	73	2B20UM	38	2C03DL	14
1DU50R	66	1G25UM	42	1P18U1/4	72	1P18U1H/33	73	2B20UR	56	2C03UL	12
1DU5L	23	1G2UM	42	1P18U1/40	72	1P18U1H/34	73	2B25UM	38	2C03UM	39
1DU5R	66	1G3.5UM	42	1P18U1/41	72	1P18U1H/35	73	2B25UR	56	2C05DL	14
1DU60L	23	1G30UM	42	1P18U1/42	72	1P18U1H/36	73	2B2UM	38	2C05UL	12
1DU60R	66	1G32UM	42	1P18U1/43	72	1P18U1H/4	73	2B2UR	56	2C05UM	39
1DU63L	23	1G3UM	42	1P18U1/44	72	1P18U1H/5	73	2B3.5UM	38	2C05UR	57
1DU63R	66	1G40UM	42	1P18U1/45	72	1P18U1H/6	73	2B30UM	38	2C075UM	39
1DU6L	23	1G4UM	42	1P18U1/46	72	1P18U1H/7	73	2B30UR	56	2C1.6DL	14
1DU6R	66	1G50UM	42	1P18U1/47	72	1P18U1H/8	73	2B32UM	38	2C1.6UL	12
1DU8L	23	1G5UM	42	1P18U1/48	72	1P18U1H/9	73	2B32UR	56	2C1.6UM	39
1DU8R	66	1G60UM	42	1P18U1/49	72	1Z03UM	43	2B3UM	38	2C10DL	14
1E03UM	41	1G63UM	42	1P18U1/5	72	1Z05UM	43	2B3UR	56	2C10UL	12
1E05UM	41	1G6UM	42	1P18U1/50	72	1Z075UM	43	2B40UM	38	2C10UM	39
1E075UM	41	1G8UM	42	1P18U1/51	72	1Z1.6UM	43	2B40UR	56	2C10UR	57
1E1.6UM	41	1P16UL3/12	30	1P18U1/52	72	1Z10UM	43	2B4UM	38	2C12DL	14

UL 489

UL 508

UL 1077

UL 1077
Equipment Breakers

Earth Leakage
Circuit Breakers

ANNEX

Index

Part No.	Page	Part No.	Page	Part No.	Page	Part No.	Page	Part No.	Page	Part No.	Page
2C12UL.....	12	2C4UL.....	12	2CU30L.....	22	2D16UL.....	13	2D60DL.....	15	2DU50R.....	66
2C12UR.....	57	2C4UM.....	39	2CU30R.....	65	2D16UM.....	40	2D60UL.....	13	2DU5L.....	23
2C13DL.....	14	2C4UR.....	57	2CU32L.....	22	2D16UR.....	58	2D60UM.....	40	2DU5R.....	66
2C13UL.....	12	2C50DL.....	14	2CU32R.....	65	2D1DL.....	15	2D60UR.....	58	2DU60L.....	23
2C13UM.....	39	2C50UL.....	12	2CU3L.....	22	2D1UL.....	13	2D63DL.....	15	2DU60R.....	66
2C13UR.....	57	2C50UM.....	39	2CU3R.....	65	2D1UM.....	40	2D63UL.....	13	2DU63L.....	23
2C15DL.....	14	2C50UR.....	57	2CU40L.....	22	2D1UR.....	58	2D63UM.....	40	2DU63R.....	66
2C15UL.....	12	2C5DL.....	14	2CU40R.....	65	2D2.5UM.....	40	2D63UR.....	58	2DU6L.....	23
2C15UM.....	39	2C5UL.....	12	2CU4L.....	22	2D20DL.....	15	2D6DL.....	15	2DU6R.....	66
2C15UR.....	57	2C5UM.....	39	2CU4R.....	65	2D20UL.....	13	2D6UL.....	13	2DU8L.....	23
2C16DL.....	14	2C5UR.....	57	2CU50L.....	22	2D20UM.....	40	2D6UM.....	40	2DU8R.....	66
2C16UL.....	12	2C60DL.....	14	2CU50R.....	65	2D20UR.....	58	2D6UR.....	58	2E03UM.....	41
2C16UM.....	39	2C60UL.....	12	2CU5L.....	22	2D25DL.....	15	2D8DL.....	15	2E05UM.....	41
2C16UR.....	57	2C60UM.....	39	2CU5R.....	65	2D25UL.....	13	2D8UL.....	13	2E075UM.....	41
2C1DL.....	14	2C60UR.....	57	2CU60L.....	22	2D25UM.....	40	2D8UM.....	40	2E1.6UM.....	41
2C1UL.....	12	2C63DL.....	14	2CU60R.....	65	2D25UR.....	58	2D8UR.....	58	2E10UM.....	41
2C1UM.....	39	2C63UL.....	12	2CU63L.....	22	2D2DL.....	15	2DU02L.....	23	2E12UM.....	41
2C1UR.....	57	2C63UM.....	39	2CU63R.....	65	2D2UL.....	13	2DU05L.....	23	2E13UM.....	41
2C2.5UM.....	39	2C63UR.....	57	2CU6L.....	22	2D2UM.....	40	2DU05R.....	66	2E15UM.....	41
2C20DL.....	14	2C6DL.....	14	2CU6R.....	65	2D2UR.....	58	2DU1.6L.....	23	2E16UM.....	41
2C20UL.....	12	2C6UL.....	12	2CU8L.....	22	2D3.5UM.....	40	2DU10L.....	23	2E1UM.....	41
2C20UM.....	39	2C6UM.....	39	2CU8R.....	65	2D30DL.....	15	2DU10R.....	66	2E2.5UM.....	41
2C20UR.....	57	2C6UR.....	57	2D03DL.....	15	2D30UL.....	13	2DU12L.....	23	2E20UM.....	41
2C25DL.....	14	2C8DL.....	14	2D03UL.....	13	2D30UM.....	40	2DU12R.....	66	2E25UM.....	41
2C25UL.....	12	2C8UL.....	12	2D03UM.....	40	2D30UR.....	58	2DU13L.....	23	2E2UM.....	41
2C25UM.....	39	2C8UM.....	39	2D05DL.....	15	2D32DL.....	15	2DU13R.....	66	2E3.5UM.....	41
2C25UR.....	57	2C8UR.....	57	2D05UL.....	13	2D32UL.....	13	2DU15L.....	23	2E30UM.....	41
2C2DL.....	14	2CU02L.....	22	2D05UM.....	40	2D32UM.....	40	2DU15R.....	66	2E32UM.....	41
2C2UL.....	12	2CU05L.....	22	2D05UR.....	58	2D32UR.....	58	2DU16L.....	23	2E3UM.....	41
2C2UM.....	39	2CU05R.....	65	2D075UM.....	40	2D3DL.....	15	2DU16R.....	66	2E40UM.....	41
2C2UR.....	57	2CU1.6L.....	22	2D1.6DL.....	15	2D3UL.....	13	2DU1L.....	23	2E4UM.....	41
2C3.5UM.....	39	2CU10L.....	22	2D1.6UL.....	13	2D3UM.....	40	2DU1R.....	66	2E50UM.....	41
2C30DL.....	14	2CU10R.....	65	2D1.6UM.....	40	2D3UR.....	58	2DU20L.....	23	2E5UM.....	41
2C30UL.....	12	2CU12L.....	22	2D10DL.....	15	2D40DL.....	15	2DU20R.....	66	2E60UM.....	41
2C30UM.....	39	2CU12R.....	65	2D10UL.....	13	2D40UL.....	13	2DU25L.....	23	2E63UM.....	41
2C30UR.....	57	2CU13L.....	22	2D10UM.....	40	2D40UM.....	40	2DU25R.....	66	2E6UM.....	41
2C32DL.....	14	2CU13R.....	65	2D10UR.....	58	2D40UR.....	58	2DU2L.....	23	2E8UM.....	41
2C32UL.....	12	2CU15L.....	22	2D12DL.....	15	2D4DL.....	15	2DU2R.....	66	2G03UM.....	42
2C32UM.....	39	2CU15R.....	65	2D12UL.....	13	2D4UL.....	13	2DU30L.....	23	2G05UM.....	42
2C32UR.....	57	2CU16L.....	22	2D12UR.....	58	2D4UM.....	40	2DU30R.....	66	2G08UM.....	42
2C3DL.....	14	2CU16R.....	65	2D13DL.....	15	2D4UR.....	58	2DU32L.....	23	2G1.6UM.....	42
2C3UL.....	12	2CU1L.....	22	2D13UL.....	13	2D50DL.....	15	2DU32R.....	66	2G10UM.....	42
2C3UM.....	39	2CU1R.....	65	2D13UM.....	40	2D50UL.....	13	2DU3L.....	23	2G12UM.....	42
2C3UR.....	57	2CU20L.....	22	2D13UR.....	58	2D50UM.....	40	2DU3R.....	66	2G13UM.....	42
2C40DL.....	14	2CU20R.....	65	2D15DL.....	15	2D50UR.....	58	2DU40L.....	23	2G15UM.....	42
2C40UL.....	12	2CU25L.....	22	2D15UL.....	13	2D5DL.....	15	2DU40R.....	66	2G16UM.....	42
2C40UM.....	39	2CU25R.....	65	2D15UM.....	40	2D5UL.....	13	2DU4L.....	23	2G1UM.....	42
2C40UR.....	57	2CU2L.....	22	2D15UR.....	58	2D5UM.....	40	2DU4R.....	66	2G2.5UM.....	42
2C4DL.....	14	2CU2R.....	65	2D16DL.....	15	2D5UR.....	58	2DU50L.....	23	2G20UM.....	42

UL 489

UL 508

UL 1077

UL 1077
Equipment Breakers

Earth Leakage
Circuit Breakers

ANNEX

Index

Part No.	Page	Part No.	Page	Part No.	Page	Part No.	Page	Part No.	Page	Part No.	Page
2G25UM.....	42	2P18U3H/20	75	2P25U3H/10	75	2Z6UM.....	43	3BU16R	64	3C2UM.....	39
2G2UM.....	42	2P18U3H/22	75	2P25U3H/12	75	2Z8UM.....	43	3BU1R	64	3C2UR	57
2G3.5UM.....	42	2P18U3H/24	75	2P25U3H/14	75	3B05UR	56	3BU20R	64	3C3.5UM.....	39
2G30UM.....	42	2P18U3H/26	75	2P25U3H/16	75	3B1.6UM.....	38	3BU25R	64	3C30UL.....	12
2G32UM.....	42	2P18U3H/28	75	2P25U3H/18	75	3B10UM.....	38	3BU2R	64	3C30UM.....	39
2G3UM.....	42	2P18U3H/30	75	2P25U3H/20	75	3B10UR	56	3BU30R	64	3C30UR	57
2G40UM.....	42	2P18U3H/32	75	2P25U3H/22	75	3B12UR	56	3BU32R	64	3C32UL.....	12
2G4UM.....	42	2P18U3H/34	75	2P25U3H/24	75	3B13UM.....	38	3BU3R	64	3C32UM.....	39
2G50UM.....	42	2P18U3H/36	75	2P25U3H/26	75	3B13UR	56	3BU40R	64	3C32UR	57
2G5UM.....	42	2P18U3H/38	75	2P25U3H/28	75	3B15UM.....	38	3BU4R	64	3C3UL.....	12
2G60UM.....	42	2P18U3H/4	75	2P25U3H/30	75	3B15UR	56	3BU50R	64	3C3UM.....	39
2G63UM.....	42	2P18U3H/40	75	2P25U3H/32	75	3B16UM.....	38	3BU5R	64	3C3UR	57
2G6UM.....	42	2P18U3H/42	75	2P25U3H/34	75	3B16UR	56	3BU60R	64	3C40UL.....	12
2G8UM.....	42	2P18U3H/44	75	2P25U3H/36	75	3B1UM.....	38	3BU63R	64	3C40UM.....	39
2P16UL3/12.....	31	2P18U3H/46	75	2P25U3H/38	75	3B1UR	56	3BU6R	64	3C40UR	57
2P16UL3/18.....	31	2P18U3H/48	75	2P25U3H/4	75	3B2.5UM.....	38	3BU8R	64	3C4UL.....	12
2P16UL3/6.....	31	2P18U3H/50	75	2P25U3H/40	75	3B20UM.....	38	3C03UL.....	12	3C4UM.....	39
2P18U3/10.....	74	2P18U3H/52	75	2P25U3H/42	75	3B20UR	56	3C03UM.....	39	3C4UR	57
2P18U3/12.....	74	2P18U3H/54	75	2P25U3H/44	75	3B25UM.....	38	3C05UL.....	12	3C50UL.....	12
2P18U3/14.....	74	2P18U3H/56	75	2P25U3H/46	75	3B25UR	56	3C05UM.....	39	3C50UM.....	39
2P18U3/16.....	74	2P18U3H/6	75	2P25U3H/48	75	3B2UM.....	38	3C05UR	57	3C50UR	57
2P18U3/18.....	74	2P18U3H/8	75	2P25U3H/50	75	3B2UR	56	3C075UM.....	39	3C5UL.....	12
2P18U3/20.....	74	2P25U3/10.....	74	2P25U3H/52	75	3B3.5UM.....	38	3C1.6UL.....	12	3C5UM.....	39
2P18U3/22.....	74	2P25U3/12.....	74	2P25U3H/54	75	3B30UM.....	38	3C1.6UM.....	39	3C5UR	57
2P18U3/24.....	74	2P25U3/14.....	74	2P25U3H/56	75	3B30UR	56	3C10UL.....	12	3C60UL.....	12
2P18U3/26.....	74	2P25U3/16.....	74	2P25U3H/6	75	3B32UM.....	38	3C10UM.....	39	3C60UM.....	39
2P18U3/28.....	74	2P25U3/18.....	74	2P25U3H/8	75	3B32UR	56	3C10UR	57	3C60UR	57
2P18U3/30.....	74	2P25U3/20.....	74	2Z03UM	43	3B3UM.....	38	3C12UL.....	12	3C63UL.....	12
2P18U3/32.....	74	2P25U3/22.....	74	2Z05UM	43	3B3UR	56	3C12UR	57	3C63UM.....	39
2P18U3/34.....	74	2P25U3/24.....	74	2Z075UM	43	3B40UM.....	38	3C13UL.....	12	3C63UR	57
2P18U3/36.....	74	2P25U3/26.....	74	2Z1.6UM.....	43	3B40UR	56	3C13UM.....	39	3C6UL.....	12
2P18U3/38.....	74	2P25U3/28.....	74	2Z10UM	43	3B4UM.....	38	3C13UR	57	3C6UM.....	39
2P18U3/4.....	74	2P25U3/30.....	74	2Z12UM	43	3B4UR	56	3C15UL.....	12	3C6UR	57
2P18U3/40.....	74	2P25U3/32.....	74	2Z13UM	43	3B50UM.....	38	3C15UM.....	39	3C8UL.....	12
2P18U3/42.....	74	2P25U3/34.....	74	2Z15UM	43	3B50UR	56	3C15UR	57	3C8UM.....	39
2P18U3/44.....	74	2P25U3/36.....	74	2Z16UM	43	3B5UM.....	38	3C16UL.....	12	3C8UR	57
2P18U3/46.....	74	2P25U3/38.....	74	2Z1UM	43	3B5UR	56	3C16UM.....	39	3CU02L.....	22
2P18U3/48.....	74	2P25U3/4.....	74	2Z2.5UM.....	43	3B60UM.....	38	3C16UR	57	3CU05L.....	22
2P18U3/50.....	74	2P25U3/40.....	74	2Z20UM	43	3B60UR	56	3C1UL.....	12	3CU05R	65
2P18U3/52.....	74	2P25U3/42.....	74	2Z25UM	43	3B63UM.....	38	3C1UM.....	39	3CU1.6L.....	22
2P18U3/54.....	74	2P25U3/44.....	74	2Z2UM	43	3B63UR	56	3C1UR	57	3CU10L.....	22
2P18U3/56.....	74	2P25U3/46.....	74	2Z3.5UM.....	43	3B6UM.....	38	3C2.5UM.....	39	3CU10R	65
2P18U3/6.....	74	2P25U3/48.....	74	2Z30UM	43	3B6UR	56	3C20UL.....	12	3CU12L.....	22
2P18U3/8.....	74	2P25U3/50.....	74	2Z32UM	43	3B8UR	56	3C20UM.....	39	3CU12R	65
2P18U3H/10	75	2P25U3/52.....	74	2Z3UM	43	3BU05R	64	3C20UR	57	3CU13L.....	22
2P18U3H/12	75	2P25U3/54.....	74	2Z40UM	43	3BU10R	64	3C25UL.....	12	3CU13R	65
2P18U3H/14	75	2P25U3/56.....	74	2Z4UM	43	3BU12R	64	3C25UM.....	39	3CU15L.....	22
2P18U3H/16	75	2P25U3/6.....	74	2Z50UM.....	43	3BU13R	64	3C25UR	57	3CU15R	65
2P18U3H/18	75	2P25U3/8.....	74	2Z5UM	43	3BU15R	64	3C2UL.....	12	3CU16L.....	22

UL 489

UL 508

UL 1077

UL 1077
Equipment Breakers

Earth Leakage
Circuit Breakers

ANNEX

Index

Part No.	Page	Part No.	Page	Part No.	Page	Part No.	Page	Part No.	Page	Part No.	Page
3CU16R	65	3D15UR	58	3D8UM	40	3E1.6UM	41	3P16UL3/12	32	3P25U3/42	76
3CU1L	22	3D16UL	13	3D8UR	58	3E10UM	41	3P16UL3/18	32	3P25U3/45	76
3CU1R	65	3D16UM	40	3DU02L	23	3E12UM	41	3P16UL3/6	32	3P25U3/48	76
3CU20L	22	3D16UR	58	3DU05L	23	3E13UM	41	3P18U3/12	76	3P25U3/51	76
3CU20R	65	3D1UL	13	3DU05R	66	3E15UM	41	3P18U3/15	76	3P25U3/54	76
3CU25L	22	3D1UM	40	3DU1.6L	23	3E16UM	41	3P18U3/18	76	3P25U3/57	76
3CU25R	65	3D1UR	58	3DU10L	23	3E1UM	41	3P18U3/21	76	3P25U3/6	76
3CU2L	22	3D2.5UM	40	3DU10R	66	3E2.5UM	41	3P18U3/24	76	3P25U3/9	76
3CU2R	65	3D20UL	13	3DU12L	23	3E20UM	41	3P18U3/27	76	3P25U3H/12	77
3CU30L	22	3D20UM	40	3DU12R	66	3E25UM	41	3P18U3/30	76	3P25U3H/15	77
3CU30R	65	3D20UR	58	3DU13L	23	3E2UM	41	3P18U3/33	76	3P25U3H/18	77
3CU32L	22	3D25UL	13	3DU13R	66	3E3.5UM	41	3P18U3/36	76	3P25U3H/21	77
3CU32R	65	3D25UM	40	3DU15L	23	3E30UM	41	3P18U3/39	76	3P25U3H/24	77
3CU3L	22	3D25UR	58	3DU15R	66	3E32UM	41	3P18U3/42	76	3P25U3H/27	77
3CU3R	65	3D2UL	13	3DU16L	23	3E3UM	41	3P18U3/45	76	3P25U3H/30	77
3CU40L	22	3D2UM	40	3DU16R	66	3E40UM	41	3P18U3/48	76	3P25U3H/33	77
3CU40R	65	3D2UR	58	3DU1L	23	3E4UM	41	3P18U3/51	76	3P25U3H/36	77
3CU4L	22	3D3.5UM	40	3DU1R	66	3E50UM	41	3P18U3/54	76	3P25U3H/39	77
3CU4R	65	3D30UL	13	3DU20L	23	3E5UM	41	3P18U3/57	76	3P25U3H/42	77
3CU50L	22	3D30UM	40	3DU20R	66	3E60UM	41	3P18U3/6	76	3P25U3H/45	77
3CU50R	65	3D30UR	58	3DU25L	23	3E63UM	41	3P18U3/9	76	3P25U3H/48	77
3CU5L	22	3D32UL	13	3DU25R	66	3E6UM	41	3P18U3H/12	77	3P25U3H/51	77
3CU5R	65	3D32UM	40	3DU2L	23	3E8UM	41	3P18U3H/15	77	3P25U3H/54	77
3CU60L	22	3D32UR	58	3DU2R	66	3G03UM	42	3P18U3H/18	77	3P25U3H/57	77
3CU60R	65	3D3UL	13	3DU30L	23	3G05UM	42	3P18U3H/21	77	3P25U3H/6	77
3CU63L	22	3D3UM	40	3DU30R	66	3G08UM	42	3P18U3H/24	77	3P25U3H/9	77
3CU63R	65	3D3UR	58	3DU32L	23	3G1.6UM	42	3P18U3H/27	77	3Z03UM	43
3CU6L	22	3D40UL	13	3DU32R	66	3G10UM	42	3P18U3H/30	77	3Z05UM	43
3CU6R	65	3D40UM	40	3DU3L	23	3G12UM	42	3P18U3H/33	77	3Z075UM	43
3CU8L	22	3D40UR	58	3DU3R	66	3G13UM	42	3P18U3H/36	77	3Z1.6UM	43
3CU8R	65	3D4UL	13	3DU40L	23	3G15UM	42	3P18U3H/39	77	3Z10UM	43
3D03UL	13	3D4UM	40	3DU40R	66	3G16UM	42	3P18U3H/42	77	3Z12UM	43
3D03UM	40	3D4UR	58	3DU4L	23	3G1UM	42	3P18U3H/45	77	3Z13UM	43
3D05UL	13	3D50UL	13	3DU4R	66	3G2.5UM	42	3P18U3H/48	77	3Z15UM	43
3D05UM	40	3D50UM	40	3DU50L	23	3G20UM	42	3P18U3H/51	77	3Z16UM	43
3D05UR	58	3D50UR	58	3DU50R	66	3G25UM	42	3P18U3H/54	77	3Z1UM	43
3D075UM	40	3D5UL	13	3DU5L	23	3G2UM	42	3P18U3H/57	77	3Z2.5UM	43
3D1.6UL	13	3D5UM	40	3DU5R	66	3G3.5UM	42	3P18U3H/6	77	3Z20UM	43
3D1.6UM	40	3D5UR	58	3DU60L	23	3G30UM	42	3P18U3H/9	77	3Z25UM	43
3D10UL	13	3D60UL	13	3DU60R	66	3G32UM	42	3P25U3/12	76	3Z2UM	43
3D10UM	40	3D60UM	40	3DU63L	23	3G3UM	42	3P25U3/15	76	3Z3.5UM	43
3D10UR	58	3D60UR	58	3DU63R	66	3G40UM	42	3P25U3/18	76	3Z30UM	43
3D12UL	13	3D63UL	13	3DU6L	23	3G4UM	42	3P25U3/21	76	3Z32UM	43
3D12UR	58	3D63UM	40	3DU6R	66	3G50UM	42	3P25U3/24	76	3Z3UM	43
3D13UL	13	3D63UR	58	3DU8L	23	3G5UM	42	3P25U3/27	76	3Z40UM	43
3D13UM	40	3D6UL	13	3DU8R	66	3G60UM	42	3P25U3/30	76	3Z4UM	43
3D13UR	58	3D6UM	40	3E03UM	41	3G63UM	42	3P25U3/33	76	3Z50UM	43
3D15UL	13	3D6UR	58	3E05UM	41	3G6UM	42	3P25U3/36	76	3Z5UM	43
3D15UM	40	3D8UL	13	3E075UM	41	3G8UM	42	3P25U3/39	76	3Z6UM	43

UL 489

UL 508

UL 1077

UL 1077
Equipment Breakers

Earth Leakage
Circuit Breakers

ANNEX

Index

Part No.	Page	Part No.	Page	Part No.	Page	Part No.	Page	Part No.	Page	Part No.	Page
3Z8UM.....	43	DC1DU63L.....	24	E983419.....	16	G45-14-4.....	53	MS.G55.....	53	RP4450.....	86
ALTN2.....	68	DC1DU6L.....	24	E983419.....	59	G45-14-5.....	53	MS.PS2.....	53	RP4503.....	86
ALTN2L.....	26	DC1DU8L.....	24	EASS.....	16	G54-14-2.....	53	MS.PV.....	53	RP4530.....	86
BRB5W.....	79	DC2CU02L.....	24	EASS.....	59	G54-14-3.....	53	MS.SLG2.....	53	RP4550.....	86
BS.UL.....	16	DC2CU05L.....	24	EASS2.....	69	G54-14-4.....	53	MS.SLG3.....	53	RP4603.....	86
BS.UL.....	59	DC2CU1.6L.....	24	EASS2L.....	27	G54-14-5.....	53	MS.SLJ2.....	53	RP4630.....	86
DC1CU02L.....	24	DC2CU10L.....	24	FA110ACL.....	26	GE2-14.....	53	MS.SLJ3.....	53	RP4650.....	86
DC1CU05L.....	24	DC2CU12L.....	24	FA110ACR.....	68	H10UL.....	16	MS.SLR2.....	53	RP4703.....	86
DC1CU1.6L.....	24	DC2CU13L.....	24	FA110DCL.....	26	H10UM.....	50	MS.SLR3.....	53	RP4730.....	86
DC1CU10L.....	24	DC2CU15L.....	24	FA110DCR.....	68	H10UM.....	59	MS.SLW2.....	53	RP4750.....	86
DC1CU12L.....	24	DC2CU16L.....	24	FA110UL.....	16	H11UL.....	16	MS.SLW3.....	53	TR11-xx.....	80
DC1CU13L.....	24	DC2CU1L.....	24	FA110UM.....	50	H11UM.....	50	MSO16.....	52	TR20-xx.....	82
DC1CU15L.....	24	DC2CU20L.....	24	FA110UM.....	59	H11UM.....	59	MSO25.....	52	TR30-xx.....	84
DC1CU16L.....	24	DC2CU25L.....	24	FA120ACL.....	26	H12UL.....	16	MSO4.....	52	UA120UL.....	16
DC1CU1L.....	24	DC2CU2L.....	24	FA120ACR.....	68	H12UM.....	50	MSO63.....	52	UA120UM.....	50
DC1CU20L.....	24	DC2CU30L.....	24	FA12ACL.....	26	H12UM.....	59	MS1.....	52	UA120UM.....	59
DC1CU25L.....	24	DC2CU32L.....	24	FA12ACR.....	68	H1COL.....	27	MS1.6.....	52	UV110ACL.....	26
DC1CU2L.....	24	DC2CU3L.....	24	FA12DCL.....	26	H1COR.....	69	MS10.....	52	UV110ACR.....	68
DC1CU30L.....	24	DC2CU40L.....	24	FA12DCR.....	68	H21UL.....	16	MS16.....	52	UV110DCL.....	26
DC1CU32L.....	24	DC2CU4L.....	24	FA12UL.....	16	H21UM.....	50	MS2.5.....	52	UV110DCR.....	68
DC1CU3L.....	24	DC2CU50L.....	24	FA12UM.....	50	H21UM.....	59	MS20.....	52	UV120ACL.....	26
DC1CU40L.....	24	DC2CU5L.....	24	FA12UM.....	59	H2COL.....	27	MS25.....	52	UV120ACR.....	68
DC1CU4L.....	24	DC2CU60L.....	24	FA230ACL.....	26	H2COR.....	69	MS4.....	52	UV12ACL.....	26
DC1CU50L.....	24	DC2CU63L.....	24	FA230ACR.....	68	HLS11L*.....	16	MS6.3.....	52	UV12ACR.....	68
DC1CU5L.....	24	DC2CU6L.....	24	FA24ACL.....	26	HLS11M.....	59	N32UL.....	16	UV12DCL.....	26
DC1CU60L.....	24	DC2CU8L.....	24	FA24ACR.....	68	HLS11M*.....	50	N63UL.....	16	UV12DCR.....	68
DC1CU63L.....	24	DC2DU02L.....	24	FA24DCL.....	26	HMS01.....	53	N63UM.....	59	UV230ACL.....	26
DC1CU6L.....	24	DC2DU05L.....	24	FA24DCR.....	68	HMS02.....	53	P35ULT.....	33	UV230ACR.....	68
DC1CU8L.....	24	DC2DU1.6L.....	24	FA24UL.....	16	HMS10.....	53	P50UB.....	78	UV24ACL.....	26
DC1DU02L.....	24	DC2DU10L.....	24	FA24UM.....	50	HMS11.....	53	P50ULB.....	33	UV24ACR.....	68
DC1DU05L.....	24	DC2DU12L.....	24	FA24UM.....	59	HMS20.....	53	P50UT.....	78	UV24DCL.....	26
DC1DU1.6L.....	24	DC2DU13L.....	24	FA277ACL.....	26	HSTCOL.....	27	P50UT-LP.....	78	UV24DCR.....	68
DC1DU10L.....	24	DC2DU15L.....	24	FA277ACR.....	68	HSTCOR.....	69	P95UB.....	79	UV277ACL.....	26
DC1DU12L.....	24	DC2DU16L.....	24	FA400ACL.....	26	MA016UM.....	48	RP2101.....	86	UV277ACR.....	68
DC1DU13L.....	24	DC2DU1L.....	24	FA400ACR.....	68	MA025UM.....	48	RP2203.....	86	UV400ACL.....	26
DC1DU15L.....	24	DC2DU20L.....	24	FA48ACL.....	26	MA040UM.....	48	RP2230.....	86	UV400ACR.....	68
DC1DU16L.....	24	DC2DU25L.....	24	FA48ACR.....	68	MA063UM.....	48	RP2303.....	86	UV48ACL.....	26
DC1DU1L.....	24	DC2DU2L.....	24	FA48DCL.....	26	MA1.0UM.....	48	RP2330.....	86	UV48ACR.....	68
DC1DU20L.....	24	DC2DU30L.....	24	FA48DCR.....	68	MA1.6UM.....	48	RP2403.....	86	UV48DCL.....	26
DC1DU25L.....	24	DC2DU32L.....	24	FA48UL.....	16	MA10UM.....	48	RP2430.....	86	UV48DCR.....	68
DC1DU2L.....	24	DC2DU3L.....	24	FA48UM.....	50	MA16UM.....	48	RP2450.....	86	UV60ACL.....	26
DC1DU30L.....	24	DC2DU40L.....	24	FA48UM.....	59	MA2.5UM.....	48	RP4203.....	86	UV60ACR.....	68
DC1DU32L.....	24	DC2DU4L.....	24	FA60ACL.....	26	MA20UM.....	48	RP4230.....	86		
DC1DU3L.....	24	DC2DU50L.....	24	FA60ACR.....	68	MA25UM.....	48	RP4250.....	86		
DC1DU40L.....	24	DC2DU5L.....	24	FMA1PL.....	27	MA32UM.....	48	RP4303.....	86		
DC1DU4L.....	24	DC2DU60L.....	24	FMA2PL.....	27	MA4.0UM.....	48	RP4330.....	86		
DC1DU50L.....	24	DC2DU63L.....	24	FMA3PL.....	27	MA40UM.....	48	RP4350.....	86		
DC1DU5L.....	24	DC2DU6L.....	24	G45-14-2.....	53	MA6.3UM.....	48	RP4403.....	86		
DC1DU60L.....	24	DC2DU8L.....	24	G45-14-3.....	53	MS.F55.....	53	RP4430.....	86		

UL 489

UL 508

UL 1077

UL 1077
Equipment Breakers

Earth Leakage
Circuit Breakers

ANNEX

Terms & Conditions

TITLE - Title to the products of ALTECH shall remain with ALTECH until payment is made in full by Customer. Such reservation of title is for the purpose of securing the purchase price and shall not relieve Customer of the duty to inspect the products upon receipt, to notify ALTECH of any deficiencies or defects, and to exercise due care in the use, installation, operation, and maintenance of the products when on the premise of the Customer or under the control of the Customer. Notwithstanding any reservation of title by ALTECH, risk of loss shall pass to customer at any time of shipment.

SHIPMENT AND DELIVERY - All orders for destination in the mainland United States (less Hawaii, Alaska and non-continental United States possessions) will be shipped F.O.B. Flemington, N.J. All destination, shipping and other charges shall be paid by the Customer in accordance with ALTECH's then current shipping and billing practices.

Delivery dates given in the acceptance of any order are approximate. ALTECH shall not be liable for delays in delivery or in performance due to causes beyond its reasonable control including acts of God, acts of Customer, acts of civil or military authority, fires, strikes or other labor disturbances, war, riot or delays in transportation. In the event of such delay, the date of delivery or performance shall be extended for a period equal to the time lost by reason of the delay.

PRICE - PRICES in any ALTECH publication are subject to change without prior notification. Catalog prices are based on prices published in the current price list. All written quotations are valid for thirty (30) days from the date of quotation. Customer shall pay all sales, use, excise or similar taxes whenever ALTECH must itself pay and/or collect such tax from Customer arising out of the sale.

PAYMENT - Customer agrees to make payment within thirty (30) days of date of the invoice from ALTECH. Customer agrees to pay a late payment charge of one and one-half percent (1.5% per month, or the maximum late payment charge permitted by applicable law, whichever is less, on any unpaid amount for each calendar month (or fraction thereof) that such payment is in default. Orders amounting to less than \$100.00 will be billed at \$100.00 plus freight. Full carton purchases are required. In the event of referral to an attorney for collection, reasonable attorney's fees for collection of the overdue amount shall be paid by Customer. In the event payment is not received within 30 days from the date of invoice, any discount shall be cancelled and the full list price will be due.

LIMITED WARRANTY - ALTECH warrants to Customer that the equipment purchases shall be free from defects in material and workmanship under normal use and service for a period of one year from shipment.

Written notice as an explanation of the circumstances of any claim that the equipment has proved defective in material or workmanship shall be given promptly by the Customer to ALTECH.

ALTECH will not be liable for any misuse, improper operations, improper installation, improper maintenance, alteration, modification, accident or unusual degradation of the equipment or parts due to an unsuitable installation environment.

No representation of other affirmation of facts, including but not limited to statements regarding capacity, suitability for use or performance of the equipment, shall be or be deemed to be a warranty or representation by ALTECH for any purpose, nor give rise to any liability or obligation of ALTECH whatsoever.

Customer's sole and exclusive remedy in the event of breach of warranty, as set forth herein, is expressly limited to (1) the correction of the defect by adjustment, repair, modification, or replacement, or (2) issuance of a credit or refund of the purchase price for the defective equipment at ALTECH's election and sole expense.

EXCEPT AS SPECIFICALLY PROVIDED IN THIS AGREEMENT, THERE ARE NO OTHER WARRANTIES EXPRESSED OR IMPLIED INCLUDING BUT NOT LIMITED TO ANY IMPLIED WARRANTIES OR MERCHANTABILITY OR FITNESS FOR A PARTICULAR PURPOSE.

THIS WARRANTY EXTENDS ONLY TO THE CUSTOMER FROM ALTECH OR ITS AUTHORIZED DISTRIBUTOR.

LIMITATION OF LIABILITY - IN NO EVENT, SHALL ALTECH BE LIABLE FOR LOSS OF PROFITS, INDIRECT, SPECIAL, CONSEQUENTIAL OR OTHER SIMILAR DAMAGES ARISING OUT OF ANY BREACH OF THIS AGREEMENT OR OBLIGATIONS UNDER THE AGREEMENT.

ALTECH SHALL NOT BE LIABLE FOR ANY DAMAGES CAUSED BY DELAY IN SHIPMENT, INSTALLATION OR FURNISHING OF EQUIPMENT OR SERVICES UNDER THIS AGREEMENT.

No action arising out of any claimed breach of this Agreement may be brought by either party more than two (2) years after the cause of action has accrued.

PATENT INDEMNITY - ALTECH shall defend or settle any suit or proceeding brought against Customer based on a claim that any equipment made to ALTECH design and furnished hereunder constitutes an infringement of any existing United States patent, provided (ALTECH) is notified promptly in writing and is given complete authorization and information required for the defense, and ALTECH shall pay all damages and costs awarded against Customer, but shall not be responsible for any costs, expense or compromise incurred or made by Customer without ALTECH's prior written consent. If any equipment is in ALTECH's opinion likely to or does become the subject of a claim for patent infringement, ALTECH may at its option and expense procure for Customer the right to continue using the device, modify it to become non-infringing, but in the event ALTECH is not reasonably able to modify, substitute, or otherwise procure for Customer the right to continue using it, ALTECH will remove such equipment and refund to Customer the amount paid in excess of a reasonable rental for past use.

ALTECH shall not be liable for any infringement or claim based upon use of the equipment in combination with other equipment not supplied by ALTECH or with modifications made by Customer.

The foregoing states the entire liability of ALTECH to Customer arising from patent infringement.

SELLER'S REMEDIES - Should Customer fail to make any payment within ten (10) days of its due date, or fail to perform any other of the Customer's obligation hereunder upon thirty (30) days written notice, or should Customer be or become insolvent or be a party to any bankruptcy receivership proceeding prior to full payment of all amounts payable hereunder, ALTECH may: (a) with or without demand or notice to customer declare the entire amount unpaid immediately due and payable; (b) enter upon the premises where the equipment may be found and remove it (Customer shall assemble the equipment and make it available to ALTECH at a place reasonably convenient to both parties and shall permit and assist ALTECH in effecting the retaking and removal of the equipment); and (c) sell any or all the equipment as permitted under applicable law, applying the proceeds of the sale to payment of the expenses of retaking, repairing and selling the equipment, reasonable attorney fees and to the satisfaction of all indebtedness then due and unpaid under this Agreement. Any surplus shall be paid to Customer and any deficiency shall be paid to ALTECH by Customer.

The remedies provided herein shall be cumulative and in addition to all other remedies provided by law or equity or under the Uniform Commercial Code.

GOVERNING LAW - This agreement will be governed by the Laws of the State of New Jersey.

GENERAL - This Agreement shall only become effective and binding when either (a) it has been accepted and executed by an authorized representative of ALTECH, or (b) the equipment has been shipped to Customer, with or without acceptance in writing hereon. Notice of acceptance is hereby waived by Customer. Customer hereby acknowledges receipt of a true and complete copy hereof.

No addition to or modification of any of the Terms and Conditions of Sale as they appear herein shall be binding upon ALTECH unless signed in writing by duly authorized representative of ALTECH in Flemington, N.J.

Typographical and clerical errors in quotations, orders and acknowledgments are subject to correction.

This Agreement is not assignable without the prior written consent of ALTECH. Any attempt to assign any of the rights, duties or obligations of this Agreement without such consent is void.

If any provision or provisions of this Agreement shall be held to be invalid, illegal or unenforceable, the validity, legality and enforceability of the remaining provisions shall not in any way be affected or impaired thereby.

ALTECH is not responsible for failure to fulfill its obligation under this Agreement due to causes beyond its control, or except as agreed herein.

THE CUSTOMER ACKNOWLEDGES THAT HE HAS READ THE AGREEMENT, UNDERSTANDS IT, AND AGREES TO BE BOUND BY ITS TERMS AND CONDITIONS. FURTHERMORE, THE CUSTOMER AGREES THAT IT IS THE COMPLETE AND EXCLUSIVE STATEMENT OF THE AGREEMENT BETWEEN THE PARTIES, WHICH SUPERSEDES ALL PROPOSALS OR PRIOR AGREEMENTS, ORAL OR WRITTEN, EXPRESSED OR IMPLIED, AND ALL OTHER COMMUNICATIONS BETWEEN THE PARTIES RELATING TO THE SUBJECT MATTER OF THIS AGREEMENT.

Here are other great products available from Altech!

Smart Relays and Digital Timers



Supports up to 48 I/Os (32 digital inputs & 16 digital outputs). DST Feature Available. Backlit LCD Screen for display & modification of pre-selected parameters of functional blocks, viewing I/O status and programming on the device. PC software for programming, online & offline simulation, documentation & printing. Designed for use in automation for commercial & Industrial sectors. Modbus Communication. UL 508 (UL File No. E352868), IEC 61000-3-2 and IEC 61000-4-2-1~11. 250 lines of ladder programming. 16 soft text messages, Time Switches, Compare Counters, Timers, Counters & 12 analog functions.

Interface Modules and Power Supplies



Altech offers a wide range of DIN Rail or panel mount cable interface modules, relay interface modules, power supplies, carrier modules, and custom designed modules. Cable to connector models include: D-Sub connectors, ribbon cable connectors, and Dip socket connectors to terminals. Standard relay modules from 1 to 16 channels, and safety relay modules from 1 to 16 channels and up to 10 poles are included. The catalog also contains switching power supplies, linear power supplies, and custom designed interface modules.

Contactors, Mini Contactors, Overload Relays and Manual Motor Starters



- Contactors
- UL508 • CSA C22.2 No.14
 - IEC 60947-2 & IEC 60947-4-2
 - 1/2HP up to 600HP @ 480V AC
 - Direct Mounting Overload Relays
 - Full line of accessories
 - UL508 Type E Manual Motor Starters
 - UL508 (Type E self-protected Manual Motor Controller)
 - CSA C22.2 No.14
 - IEC 60947-2 & IEC 60947-4-2
 - Type F combination Manual Motor Controller (with MC-Series Contactor)

Terminal Blocks



Altech offers a NEW Terminal Block catalog with the most competitively priced blocks in the industry. We feature screw and spring clamp models for DIN rail and panel mount applications. This advanced line of wire termination products will increase your design options and help to get the job done more efficiently. Our line of blocks include feed-through (single, double or triple level), distribution, ground, fuse, disconnect, thermocouple, surge suppressor and indicator. A wide variety of accessories, tools and ferrules are available.

Industrial Enclosures



Altech offers a broad selection of non-metallic and aluminum Industrial Enclosures to meet your diverse design requirements. Sizes range from 1.97 x 2.05 x 1.38 to 35.43 x 11.81 x 5.59 inches. Materials include polycarbonate, polystyrene, polypropylene, ABS or aluminum. Polycarbonate and aluminum series have been recently expanded. Protection up to IP67 (NEMA 4, 4X). Smooth sidewalls or sidewalls with knockouts. Enclosures can be mounted directly onto a panel, frame or other mounting surfaces. EMI / RFI Coating is available. Competitive cover printing is available. Hinge Kits. Customization available.

Liquid Tight Strain Reliefs



This 64-page catalog introduces Altech's full line Liquid Tight Strain Reliefs (Cord Grips) which are used to seal cable entries, keep contaminants from entering enclosures, provide strain relief and thus reduce stress on components and termination points inside enclosures. Available in standard, high-performance, and economy versions, functions include Straight-Through, Increased Strain Relief, Bend Protection, Pull/Bend Protection, Multi-conductor, Flat Cable and EMI/RFI. They can be used with almost any type of cable, cord or conductor - solid, stranded, flat, shielded, high temperature, etc.

DIN Rail Power Supplies



Altech DIN RAIL mountable power supplies have Universal AC input. They are suitable for industrial and automation applications. UL508 Listed or UL Recognized. Single and Three phases up to 960W. Outputs of 5V, 12V, 15V, 24V and 48V. Class 2 devices are available. Installed on DIN rail TS35/ 7.5 or 15. Protections of Short circuit / Overload / Overvoltage / Over temperature. Cooling by free air convection. All-In-One DC-UPS, battery based. Ultra Capacitor DC-UPS, no battery required. Worldwide approvals. 3 year warranty.

Motor Disconnect Switches



Altech's line of Motor Disconnect Switches are UL 508 listed as Manual Motor Controllers for AC Motor Starting Across-the-line and AC General use. This new 16 page catalog includes the 3 different handle designs, which are all available in gray/black or yellow/red housings. Electrical ratings are 25-150A / 600V. The switches are non-fused DIN Rail mountable. Neat features include: snap-on auxiliary switches, door mounting kit and a retrofit 30A fuse holder. Also featured are Enclosed Motor Disconnect Switches & Fused Enclosed Motor Disconnect Switch (30A) in plastic or stainless housings.

UL 489

UL 508

UL 1077

UL 1077
Equipment Breakers

Earth Leakage
Circuit Breakers

ANNEX

Altech Search

Google



Home

Stock Check

Distributors

Information

News

Contact

Rep/Disti Login

Altech Mexico

WEB TOOLS

Altech Videos

Product Crossings

Request for Quote

Sample Request

Catalog Request

eBook Catalog

PRODUCT MENU

ATEX Products

Circuit Protection / Control

Connectors

Enclosures

European Spare Parts

Digital Panel Meters

Foot Switches

Interface Modules

Panel Accessories

Power Supplies

Power Semi-Conductors

Programmable Controllers

Push Buttons & Pilot Lights

Relays

Sensors

Safety Switches & Enclosures

Solid State Relays

Terminal Blocks

Test & Measurement

Tower Lights

New Products and Promotions

AS SHORT AS **2** Week Turn Around

CUSTOM ASSEMBLY and Valued Added Services

Imprinting

Relay Modules

Light Assemblies

Interface Modules

Component Carrier Modules

Foot Switch Assemblies

DIN Rail Assemblies

Enclosure Milling

Click for your local
ALTECH REPRESENTATIVE



Serving the Automation & Control Industry
Since 1984

CIRCUIT PROTECTION



Circuit Protection Devices



Busbar & Power Distribution



Contactors, Overload Relays, Manual Motor Starters



Motor Disconnect Switches



European Fuses & Holders

CONNECTORS



Pin & Sleeve Devices



Receptacles



Industrial Rectangular Connectors



Industrial & ATEX Enclosures



DIN Enclosures

FOOT SWITCHES



Industrial



Medical



Interface Modules



Safety Relays



Industrial & Slimline Relays

MODULES & RELAYS

Altech Corporation
35 Royal Road
Flemington, NJ 08822-6000
Phone (908) 806-9400
Fax (908) 806-9490
www.altechcorp.com